

# DURABAND\*

with **BUILT-IN STRAP**

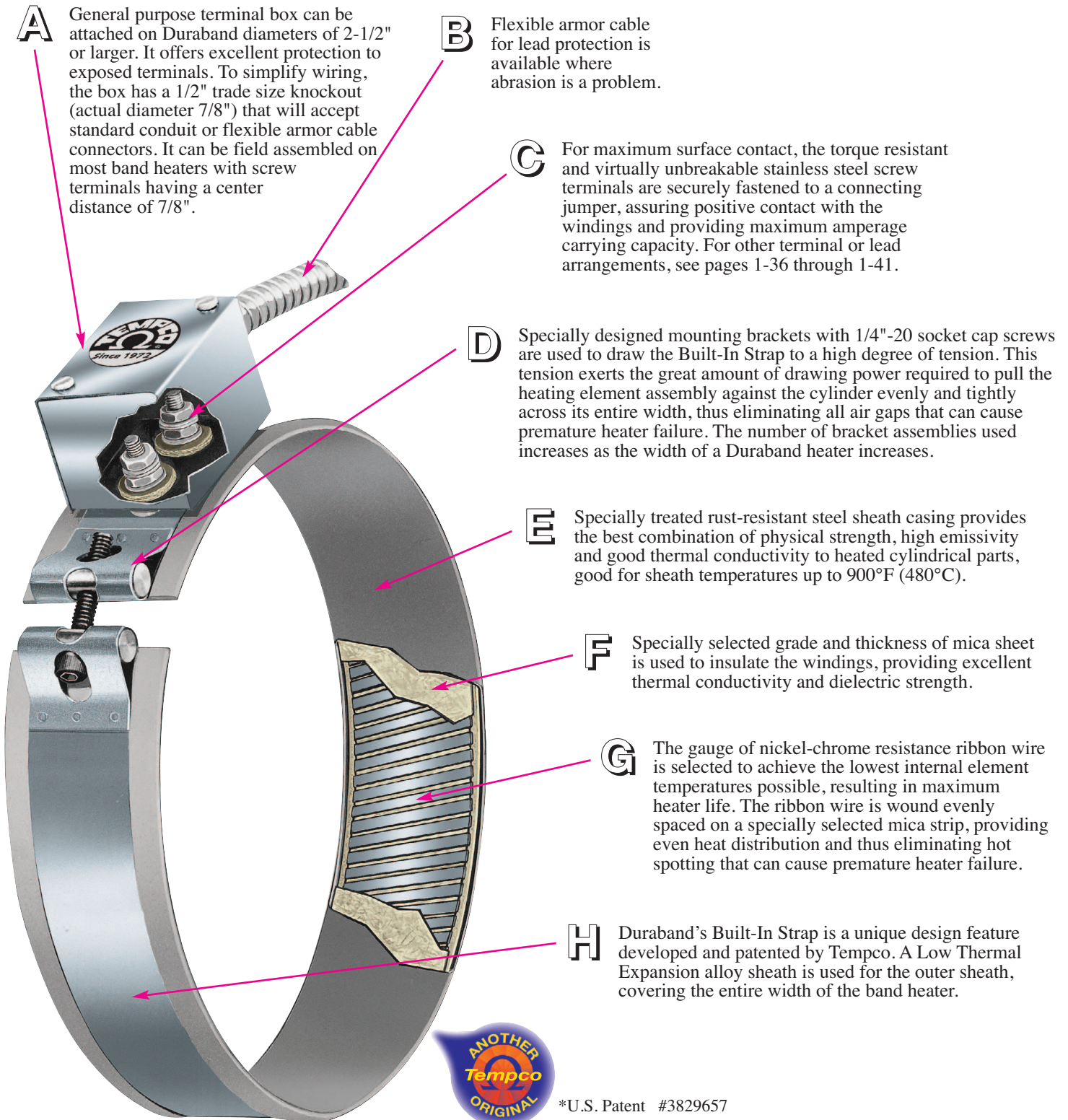

**A** General purpose terminal box can be attached on Duraband diameters of 2-1/2" or larger. It offers excellent protection to exposed terminals. To simplify wiring, the box has a 1/2" trade size knockout (actual diameter 7/8") that will accept standard conduit or flexible armor cable connectors. It can be field assembled on most band heaters with screw terminals having a center distance of 7/8".

**B** Flexible armor cable for lead protection is available where abrasion is a problem.

**C** For maximum surface contact, the torque resistant and virtually unbreakable stainless steel screw terminals are securely fastened to a connecting jumper, assuring positive contact with the windings and providing maximum amperage carrying capacity. For other terminal or lead arrangements, see pages 1-36 through 1-41.

**D** Specially designed mounting brackets with 1/4"-20 socket cap screws are used to draw the Built-In Strap to a high degree of tension. This tension exerts the great amount of drawing power required to pull the heating element assembly against the cylinder evenly and tightly across its entire width, thus eliminating all air gaps that can cause premature heater failure. The number of bracket assemblies used increases as the width of a Duraband heater increases.

**E** Specially treated rust-resistant steel sheath casing provides the best combination of physical strength, high emissivity and good thermal conductivity to heated cylindrical parts, good for sheath temperatures up to 900°F (480°C).

**F** Specially selected grade and thickness of mica sheet is used to insulate the windings, providing excellent thermal conductivity and dielectric strength.

**G** The gauge of nickel-chrome resistance ribbon wire is selected to achieve the lowest internal element temperatures possible, resulting in maximum heater life. The ribbon wire is wound evenly spaced on a specially selected mica strip, providing even heat distribution and thus eliminating hot spotting that can cause premature heater failure.

**H** Duraband's Built-In Strap is a unique design feature developed and patented by Tempco. A Low Thermal Expansion alloy sheath is used for the outer sheath, covering the entire width of the band heater.



\*U.S. Patent #3829657

## ***makes handling and installation easier!***

### **Typical Applications**

- ↪ *Plastic Injection Molding Machines*
- ↪ *Plastic Extruders*
- ↪ *Oil Reclamation Equipment*
- ↪ *Food and Candy Extruders*
- ↪ *Drum Heating*
- ↪ *Extrusion Dies*
- ↪ *Holding Tanks*
- ↪ *Blow Molding Machines*
- ↪ *Vending Machines*
- ↪ *Barrels & Heads*
- ↪ *Food Service Warming*
  - ↪ *Autoclaves & Sterilizers*
  - ↪ *Metallurgical Analyzers*
  - ↪ *Fluidized Beds*
- ↪ *Hot Runner Molds*
- ↪ *Pulp and Paper Processing Equipment*

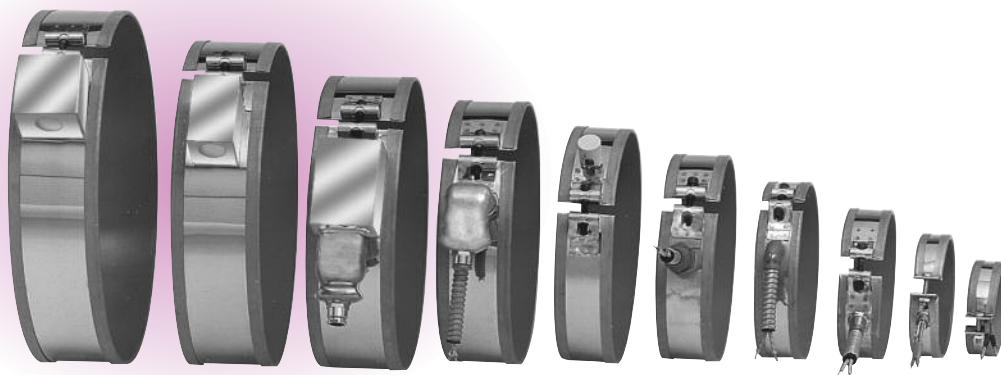

### **Designed For Trouble-Free Service**

Tempco's Duraband heater design is the result of many years of research, development and testing for a reliable mica insulated band heater that can perform at the higher operating temperatures [up to 900°F (480°C)] essential to process high temperature resins, providing long, efficient service necessary for today's high productivity of plastic extruders, injection and blow molding machines.

Duraband is a proven heater design for good life efficiency and dependability. It assures maintaining the lowest winding temperatures possible, keeping a low-mass heating element assembly for fast heat-up and quick thermal response to controls. It incorporates the Low Thermal Expansion Built-In Strap, a unique design feature originally developed and patented by Tempco.

### **Advantages and Variations**

Duraband mica insulated heaters are widely used on operations involving heating of cylindrical surfaces and are manufactured in a full range of standard construction variations, physical dimensions, electrical ratings, and a complete arrangement of screw terminals and lead terminations. (See pages 1-36 through 1-41).

However, these standard Duraband heater variations and terminations do not represent the full extent of our capabilities. Tempco's engineering staff, with many years of experience in heat processing and temperature control applications, can assist you in designing the right Duraband heater for your specific application.

### **Construction Characteristics & Features**

- \* *Built-in bracket for superior clamping*
- \* *Unbreakable and torque-resistant screw terminals*
- \* *Temperatures up to 900°F (480°C)*
- \* *Full width stainless steel built-in strap*
- \* *Flexibility to incorporate holes and cutouts*
- \* *Available two-piece and expandable designs*
- \* *Best mica insulated heater on the market*
- \* *Faster delivery than any other type of heater band*
- \* *Most economical among various heater bands*
- \* *Most versatile and commonly used heater band*

## Duraband Specifications

### Duraband® Standard Specifications and Tolerances

#### PERFORMANCE RATINGS

**Maximum Temperature:** Standard Sheath: 900°F (482°C)

**Nominal Watt Density:** 20-45 W/in<sup>2</sup> (3-7 W/cm<sup>2</sup>)

**Maximum Watt Density:** Dependent on heater size and operating temperature.

#### ELECTRICAL RATINGS

**Maximum Voltage:** 480 VAC

**Dual Voltage or 3-Phase:**

Available depending on heater design

**Maximum Amperage:** lead wire termination: 12.5 amp  
screw terminations: 8-32UNF—20 amp; 10-32UNF—25 amp

**Resistance Tolerance:** +10%, -5%

**Wattage Tolerance:** +5%, -10%



Exposed electrical wiring on band heater installations is a violation of Electrical Safety Codes including O.S.H.A.

#### PHYSICAL SIZE CONSTRUCTION LIMITATIONS

**Minimum Width:** 3/4" (19.1 mm)

**Width Tolerance:** ±1/16" (1.59 mm)

**Minimum Inside Diameter:** 7/8" (22.1 mm)

**Nominal Gap:** 3/8" (9.5 mm)—If a larger gap is required for probes or thermocouples, specify when ordering.

#### BUILT-IN BRACKETS

Heater Width	Number of Brackets
1-1/2" to 3" (38-76 mm)	1
3-1/8" to 5" (79-127 mm)	2
5-1/8" to 6-7/8" (130-145 mm)	3
7" to 10" (178-254 mm)	4
10-1/8" to 15" (257-381 mm)	5

*If tighter tolerances are required, consult Tempco.*

#### Minimum ID and Width for Construction/Clamping Styles

Style	Min. ID		Min. Width	
	in	mm	in	mm
NB	2	50.8	1-1/4	31.8
NS	3	76.2	1-1/4	31.8
NE	2-1/2	63.5	1-1/4	31.8
SB	7/8	22.1	3/4	19.1
SS	2	50.8	3/4	19.1
SE	2-1/2	63.5	1-1/4	31.8
FB	1	25.4	3/4	19.1
FS	2	50.8	3/4	19.1
FE	2-1/2	63.5	1-1/4	31.8
SL	4	101.6	1-1/4	31.8
NSL	4	101.6	1-1/4	31.8
NEL	4	101.6	1-1/4	31.8
LT	7	177.8	1-1/2	38.1
LS	7	177.8	1-1/2	38.1
LE	7	177.8	1-1/2	38.1
TWL	1	25.4	1	25.4
RNB	5-1/2	134.7	1	25.4
RNS	10	254	1	25.4

#### Recommended Segments by Inner Diameter

Number of Segments	ID Range in	ID Range mm
1	15-1/2" & Smaller	393.7mm & Smaller
2	15 1/2" to 28"	393.7mm to 711.2mm
3	15 1/2" to 45"	393.7mm to 1143mm
4	15 1/2" to 56"	393.7mm to 1422.4mm
6	15 1/2" to 86"	393.7mm to 2184.4mm
8	25" to 96"	393.7mm to 2438.4mm



**Note:** Refer to individual descriptions for further information. Actual heater minimums will be determined by the combination of termination and construction/strap styles.

### Duraband® Maximum Watt Densities

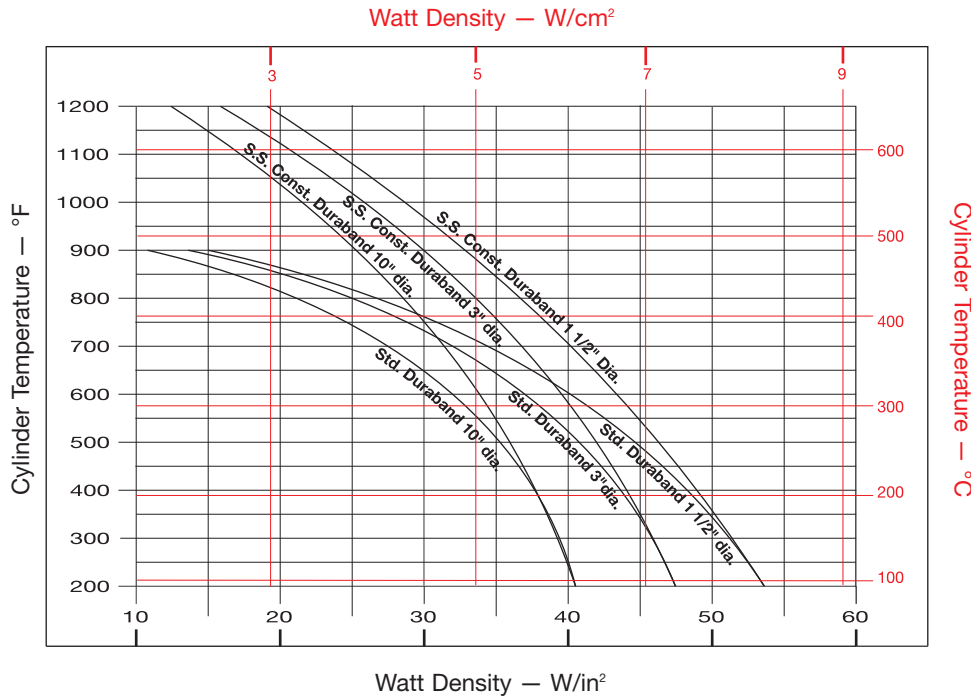

#### MAXIMUM ALLOWABLE WATT DENSITY

The chart displays the maximum Watt Density curves for various diameter heaters. Use this chart when determining the appropriate wattage value for your chosen heater.

Be aware that certain factors will require you to derate the watt density (W/in<sup>2</sup>) of your heater selection.

**CAUTION** Failure to adhere to the maximum allowable watt density per heater size will result in poor operating life.

#### CORRECTION FACTORS

For heaters wider than 3" (76.2 mm), reduce maximum recommended watt density from chart by 20%.

For applications using insulating shroud, reduce maximum recommended watt density from chart by 25%.

#### CALCULATING MAXIMUM WATT DENSITY

##### Factors to be taken into consideration

- A. Type of controls
- B. Voltage variations
- C. Machine cycling rate
- D. Type of resin being processed
- E. Coefficient of thermal expansion and conductivity of the cylinder
- F. Designing a heater that closely matches the wattage requirement will decrease the frequency of cycling and temperature overshoot, thereby increasing the life of the heater.

Once these factors have been established, proceed with the following steps:

1. Determine the maximum operating temperature.
2. Calculate the total wattage required to obtain the maximum operating temperature. (See engineering section.)
3. Determine the quantity and size of the heater bands to be used. 1-1/2" through 3" wide band heaters have proven to be the most efficient and reliable in most cylindrical heating applications.
4. Determine individual band heater wattage by dividing the total required wattage by the quantity of band heaters selected.
5. Determine the band heater watt density by subtracting unheated areas from the band heater diameter created by screw terminals, gaps, holes, and cutouts (see formula below).
6. Determine if the required watt density previously calculated exceeds the maximum recommended watt density. Note the maximum cylinder temperature required on the left-hand side of the graph, follow the horizontal line until it intersects with the line of the band heater being used, and read directly down to obtain the maximum recommended watt density (W/in<sup>2</sup>).
7. If the calculated watt density is higher than the recommended value, it must be corrected or it will cause poor heater life. This can be accomplished by using more band heaters, lowering the heater wattage, or using a different construction type or a different type of band heater.
8. Should you have a problem in selecting the proper band heater or establishing watt density for your application, consult with one of the qualified engineers at Tempco.

Nominal Unheated Areas	
Construction Style	Unheated Area to Subtract
One-piece band	1" × width
Two-piece band	2" × width
Holes and cutouts	Size + 1/2" × width

#### Watt Density Formula

$$\text{Watt Density (W/in}^2\text{)} = \frac{\text{Wattage}}{(3.14 \times (\text{Band ID}) - \text{Gap} - 1 - 3/8) \times \text{Band Width} - \text{Unheated Area (see table)}}$$

Unheated Area (See Table) = Unheated area for construction style + unheated area for any holes or cutouts

### Duraband® Construction Styles

# 3 CONSTRUCTION TYPES

#### One-Piece Band

The one-piece construction is available on any screw or lead termination and clamping variation. It can be used where band heaters can be slipped over the end of the cylinder.

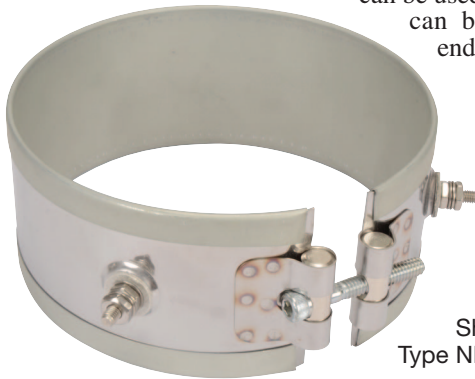

Shown with Type NB Built-In Strap

#### Two-Piece Band

The Two-Piece construction is available on any screw or lead and clamping variation. The Duraband two-piece design provides a **built-in hinge**, making handling and installation easier. It is used on large cylinders or where the heater cannot be slipped over the end of the cylinder. Two-piece band heaters are rated at watts and volts per each half when ordering.

**NOTE:** Multiple segment designs are recommended on larger diameter (typically larger than 15") heaters to improve the clamping force and



Shown with Type NS Built-In Strap

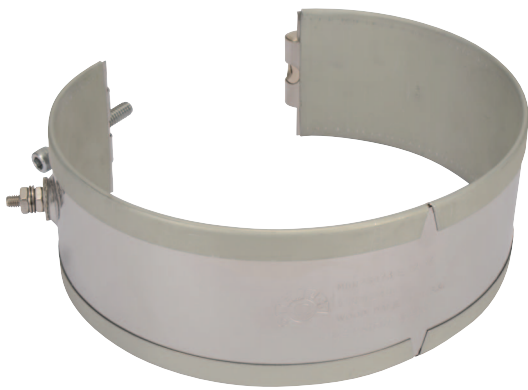

Shown with Type NE Built-In Strap

#### One-Piece Expandable Band

The one-piece expandable construction is available on any screw or lead and clamping variation. It can be used where a one-piece band heater would have to be expanded to fit over the barrel during installation, rather than slipped over the end of the barrel.



**Note:** The One-Piece Expandable Band should not be opened and closed more than twice.

### Duraband® Construction/Clamping Variations

#### Standard Built-In Strap Clamping (Low Thermal Expansion)

The Built-In Strap is available with any screw or lead termination and construction variation. The Built-In Strap eliminates the use of awkward-to-handle separate straps, providing more drawing power than any other type of clamping system. The Duraband with Built-In Strap is standard on many designs.

Consult Tempco for multiple segment heaters.

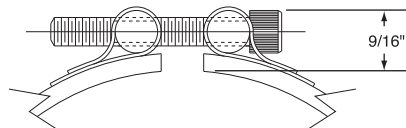

Type NB Shown

**Type NB—One-Piece Band**  
**Min. ID:** 2" (50.8 mm)  
**Min. Width:** 1-1/4" (31.8 mm)

**Type NS—Two-Piece Band**  
**Min. ID:** 3" (76.2 mm)  
**Min. Width:** 1-1/4" (31.8 mm)

**Type NE—One-Piece Expandable Band**  
**Min. ID:** 2-1/2" (63.5 mm)  
**Min. Width:** 1-1/4" (31.8 mm)

### Duraband® Construction/Clamping Variations

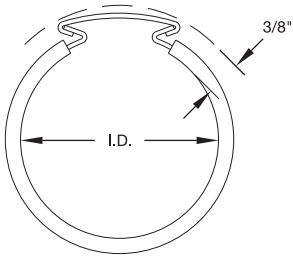

#### Wedge Lock

Wedge Lock clamping is designed for applications where mounting space is severely limited. It lends itself mainly to small diameter nozzle heaters.

##### Type TWL—One-Piece Band

- Min. ID:** 1" (25.4 mm)
- Min. Width:** 1" (25.4 mm)
- Max. Width:** 3-1/2" (88.9 mm)



#### Separate Straps

The Separate Strap clamping is available with any screw or lead termination and construction variation. It is strongly recommended that the Duraband with Built-In Strap design be used whenever possible because it provides more drawing power than any other type of clamping system.

Consult Tempco for multiple segment heaters.



Type SB Shown

##### Type SB—One-Piece Band

- Min. ID:** 7/8" (22.2 mm)
- Min. Width:** 3/4" (19.1 mm)

##### Type SS—Two-Piece Band

- Min. ID:** 2" (50.8 mm)
- Min. Width:** 3/4" (19.1 mm)

##### Type SE—One-Piece Expandable Band

- Min. ID:** 2-1/2" (63.5 mm)
- Min. Width:** 1-1/4" (31.8 mm)

#### Clearance Dimensions for Separate Strap Clamping

Separate strap clearance dimensions are dependent on heater ID. The strap dimensions are shown below.

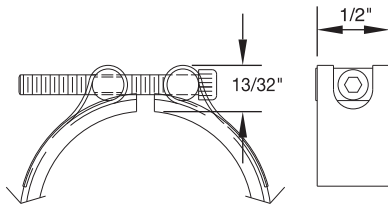

< 2" ID — 6-32 Screw

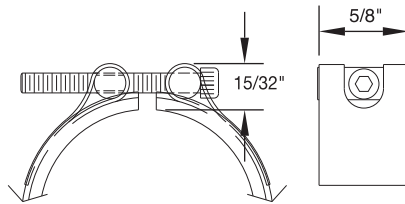

2 to 3-1/2" ID — 8-32 Screw

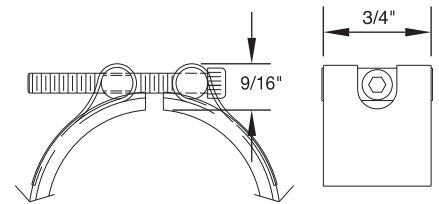

> 3-1/2" ID — 1/4-20 Screw



#### Spring Loaded with Built-In Bracket

The Heavy Duty Stainless Steel Spring with Built-In Bracket is a variation on the basic Duraband design. It is available with any screw or lead termination and construction variation. It is recommended for heaters over 12" in diameter, and for any diameter heater used in the vertical position, to prevent the heater from slipping off the machine. The springs provide constant tension, therefore maintaining optimum surface contact against the cylinder being heated.

Consult Tempco for multiple segment heaters.

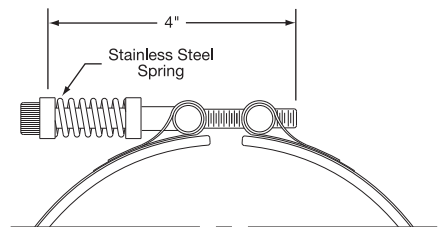

##### Type SL—One-Piece Band

- Min. ID:** 4" (101.6 mm)
- Min. Width:** 1-1/4" (31.8 mm)

##### Type NSL—Two-Piece Band

- Min. ID:** 4" (101.6 mm)
- Min. Width:** 1-1/4" (31.8 mm)

##### Type NEL—One-Piece Expandable Band

- Min. ID:** 4" (101.6 mm)
- Min. Width:** 1-1/4" (31.8 mm)

### Duraband® Construction/Clamping Variations

#### Spring Loaded Quick Disconnect



This construction style is a hybrid between the Spring Loaded Clamp with Built-In Bracket and the Latch and Trunnion style clamping. Utilizing a built in bracket and heavy duty flanges, this clamping style is durable and easy to work with in the field. The spring provides relief for thermal expansion and provides strong clamping for the band. This clamping style is available with either lead or screw terminal type terminations.

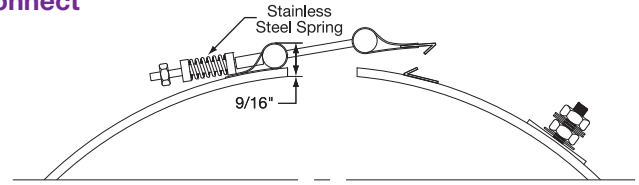

Consult Tempco for multiple segment heaters.

#### Type SLQD One-Piece Band

Min. ID: 3.5" (88.9 mm)  
Min. Width: 1.25" (31.75 mm)

#### Type NSLQD Two-Piece Band

Min. ID: 4" (101.6 mm)  
Min. Width: 1.25" (31.75 mm)

#### Type NELQD One-Piece Expandable Band

Min. ID: 3.5" (88.9 mm)  
Min. Width: 1.25" (31.75 mm)



#### Latch and Trunnion

The Latch and Trunnion Clamping System is available with any screw or lead termination and construction variation. It is ideal in absorbing thermal expansion due to the spring loading on the screws. The latch fully opens, facilitating installation on large diameter cylinders. The outer sheath is made from a Low Thermal Expansion alloy.

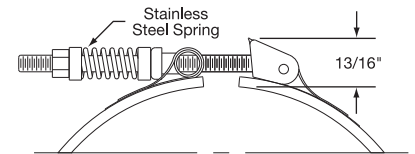

Consult Tempco for multiple segment heaters.

#### Type LT—One-Piece Band

Min. ID: 7" (177.8 mm)  
Min. Width: 1-1/2" (38.1 mm)

#### Type LS—Two-Piece Band

Min. ID: 7" (177.8 mm)  
Min. Width: 1-1/2" (38.1 mm)

#### Type LE—One-Piece Expandable Band

Min. ID: 7" (177.8 mm)  
Min. Width: 1-1/2" (38.1 mm)



#### Bent-Up Flange (Ears)

The Bent-Up Flange clamping is available with any screw or lead termination and construction variation. The outer sheath is made from a Low Thermal Expansion alloy. The Bent-Up Flange design is best suited for narrow band heaters with small diameters.

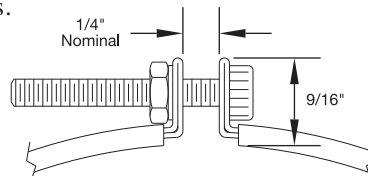

**Note:** The Bent-Up flange design should only be used when other clamping methods are not suitable for a specific application. Tempco recommends Built-In Strap Clamping be used whenever possible, especially on large diameter heaters, because it provides superior clamping power.

#### Type FB—One-Piece Band

Min. ID: 1" (25.4 mm)  
Min. Width: 3/4" (19.1 mm)

#### Type FS—Two-Piece Band

Min. ID: 2" (50.8 mm)  
Min. Width: 3/4" (19.1 mm)

#### Type FE—One-Piece Expandable Band

Min. ID: 2-1/2" (63.5 mm)  
Min. Width: 1-1/4" (31.8 mm)

### Duraband® Internal Reverse Bands

#### Type RN□—Internal Reverse Band (with bracket clamping)

This construction style is used to heat cylindrical surfaces from the inside on heaters 5-1/2" diameter and larger.

##### Type RNB—Reverse 1-Piece Construction

**ID:** 5-1/2" (139.7 mm) to 10" (254.0 mm)  
**Width:** 1" (25.4 mm) to 3-1/2" (88.9 mm)  
**Maximum Voltage:** 240VAC

##### Type RNS—Reverse 2-Piece Construction

**ID:** 10" (254.0 mm) to 20" (508.0 mm)  
**Width:** 1" (25.4 mm) to 3-1/2" (88.9 mm)  
**Maximum Voltage:** 240VAC



#### Type RTWL—Internal Reverse Band (with wedge lock clamping)

This construction style is used to heat cylindrical surfaces from the inside on heaters less than 5" outside diameter.

**ID:** Less than 5-1/2" (139.7 mm)  
**Width:** 1" to 3-1/2" (25.4 - 88.9 mm)

*For IDs greater than 20", consult Tempco with your requirements.*

### Duraband Partial Coverage

#### Type NS — 2-Piece With Built-In Brackets

Partial coverage band heaters are normally required when holes and cutouts will not allow the heater to sufficiently clear the machine obstructions. The preferred method of construction is the Two-Piece Band Heater with Built-In Brackets as illustrated. The heater is screwed down to the cylinder at the ends and the built-in Low Thermal Expansion Strap pulls the heater tightly against the cylinder being heated. The standard center of hole to edge of heater dimension is 1/4". When ordering, please provide the angle of coverage from center to center of the mounting screw holes as shown.

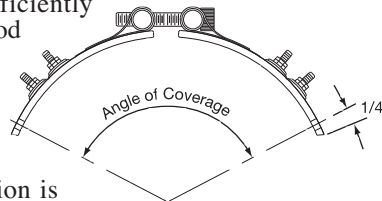

#### Type PS — One-Piece with Two-Piece Separate Strap with Padded Ends

The alternate method of partial coverage construction is the One-Piece Band Heater with a separate Two-Piece Strap. The two-piece strap itself is screwed down at the padded ends, allowing the heater to float between the pads as illustrated. When the strap is tightened, it will pull the heater against the cylinder being heated. The standard center of hole to edge of heater dimension is 1/4". When ordering, please provide the angle of coverage from center to center of the mounting screw holes as shown.

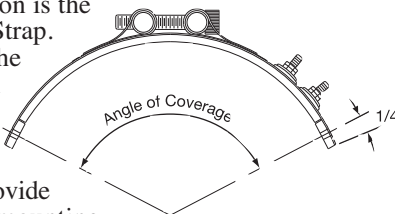

#### Type NB — One-Piece with Built-In Strap Clamping

Another alternate method of partial coverage construction. The one piece with clamp screws on both sides allows it to be secured to anchor points on either side of a barrel without drilling holes into the barrel.

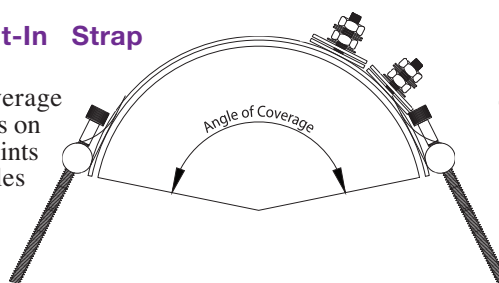



## Terminations

### **Stainless Steel Power Terminals: Type T1, Type T2 & Type T3**

Available on any clamping or construction variation, the specially designed Stainless Steel Power Terminals are internally connected to the heater and are resistant to over-torquing. The screw terminals are virtually unbreakable. Secure tightening of the electrical connections is essential for safety and long heater life.

#### **Duraband® Type T1 – Screw Terminals**

Considered standard on most band heaters unless otherwise specified.

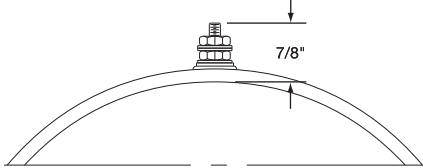

#### **One-Piece Band**

**Standard Termination Location:**  
each side of gap; center of width

- \* **Minimum Inside Diameter:** 2" (50.8 mm)
- \* **Minimum Width:** 7/8" (22.2 mm)
- \* **Post Terminals:** 10-32 standard except 8-32 on < 1" wide heaters & heaters with ID < 3"
- \* **Max. Volts/Amps:** 480VAC/ 25A (10-32) or 20A (8-32)

#### **Two-Piece Band**

**Standard Termination Location:**  
next to gaps on each half;  
center of width

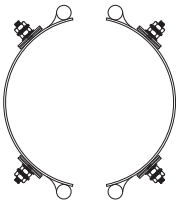

- \* **Minimum Inside Diameter:** 2" (50.8 mm)
- \* **Minimum Width:** 7/8" (22.2 mm)
- \* **Post Terminals:** 10-32 standard except 8-32 on < 1" wide heaters & heaters with ID < 3"
- \* **Max. Volts/Amps:** 480VAC/ 25A (10-32) or 20A (8-32) each half

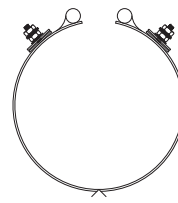

#### **One-Piece Expandable Band**

**Standard Termination Location:**  
each side of gap; center of width

- \* **Minimum Inside Diameter:** 2-1/2" (63.5 mm)
- \* **Minimum Width:** 1-1/4" (31.8 mm)
- \* **Post Terminals:** 10-32 standard except 8-32 on heaters with ID < 3"
- \* **Max. Volts/Amps:** 480VAC/ 25A (10-32) or 20A (8-32)

#### **Duraband Type T2 – Screw Terminals**

Recommended for narrow band heaters where screw terminals are preferred or the C2 terminal box protection is required.

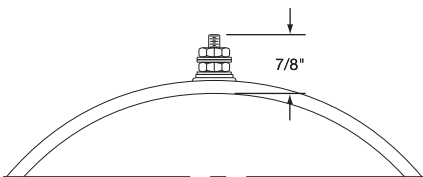

#### **One-Piece Band**

**Standard Termination Location:**  
next to gap; center of width

- \* **Minimum Inside Diameter:** 2" (50.8 mm)
- \* **Minimum Width:** 7/8" (22.2 mm)
- \* **Post Terminals:** 10-32 standard except 8-32 on < 1" wide heaters & heaters with ID < 3"
- \* **Max. Volts/Amps:** 480VAC/ 25A (10-32) or 20A (8-32)

#### **Two-Piece Band**

**Standard Termination Location:**  
next to same gap on each half;  
center of width

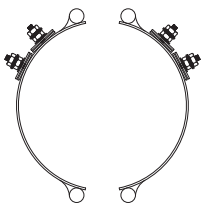

- \* **Minimum Inside Diameter:** 2" (50.8 mm)
- \* **Minimum Width:** 7/8" (22.2 mm)
- \* **Post Terminals:** 10-32 standard except 8-32 on < 1" wide heaters & heaters with ID < 3"
- \* **Max. Volts/Amps:** 480VAC/ 25A (10-32) or 20A (8-32) each half

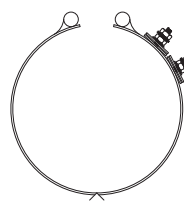

#### **One-Piece Expandable Band**

**Standard Termination Location:**  
next to gap; center of width

- \* **Minimum Inside Diameter:** 2-1/2" (63.5 mm)
- \* **Minimum Width:** 1-1/4" (31.8 mm)
- \* **Post Terminals:** 10-32 standard except 8-32 on heaters with ID < 3"
- \* **Max. Volts/Amps:** 480VAC/ 25A (10-32) or 20A (8-32)

### Duraband® Type T3 – Screw Terminals

The preferred design on band heaters over 3" (76.2 mm) wide or when C3 terminal box is required.

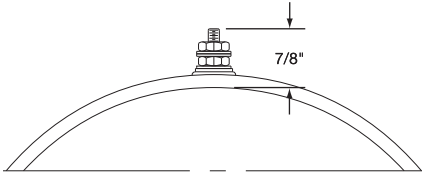

#### One-Piece Band

**Standard Termination Location:**  
next to gap; across center of width

- \* **Minimum Inside Diameter:** 2" (50.8 mm)
- \* **Minimum Width:** 2" (50.8 mm)
- \* **Post Terminals:** 10-32 standard except 8-32 on 2" to 2-1/2" wide heaters & heaters with ID < 3"
- \* **Max. Volts/Amps:** 480VAC/25A (10-32) or 20A (8-32)

#### Two-Piece Band

**Standard Termination Location:**  
next to same gap on each half;  
across center of width

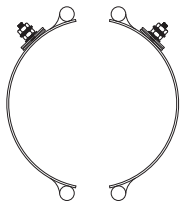

- \* **Minimum Inside Diameter:**  
2" (50.8 mm)
- \* **Minimum Width:** 2" (50.8 mm)
- \* **Post Terminals:** 10-32 standard except 8-32 on 2" to 2-1/2" wide heaters & heaters with ID < 3"
- \* **Max. Volts/Amps:** 480VAC/  
25A (10-32) or 20A (8-32) each half

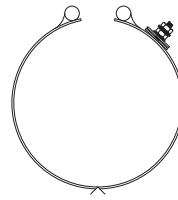

#### One-Piece Expandable Band

**Standard Termination Location:**  
next to gap; across center of width

- \* **Minimum Inside Diameter:**  
2-1/2" (63.5 mm)
- \* **Minimum Width:** 2" (50.8 mm)
- \* **Post Terminals:** 10-32 standard except 8-32 on 2" to 2-1/2" wide heaters & heaters with ID < 3"
- \* **Max. Volts/Amps:** 480VAC/  
25A (10-32) or 20A (8-32)

### Optional Igloo™ Ceramic Covers for Heaters with Screw Terminals

**Igloo™ Ceramic Terminal Covers** consist of two individual ceramic parts. Unlike conventional ceramic caps, Igloo fully insulates any standard #8 or #10 terminal lugs used for electrical hook-ups.

#### Limitations

To assemble Igloo covers, terminals should be at least 7/8" apart.

**Min. ID:** 2" (50.8 mm) **Min. Width:** 1-1/4" (31.7 mm)

Three types of Igloo™ bases are available:

- Type C6** – Double Port In-Line P/N CER-101-104
- Type C7** – Double Port 90° P/N CER-101-106
- Type C8** – Single Port P/N CER-101-107

Igloo™ caps are available in the following three screw terminal sizes:

- 10-32** – P/N CER-102-101
- 10-24** – P/N CER-102-104
- 8-32** – P/N CER-102-105

When ordering, specify the type of Igloo and the screw terminal size.

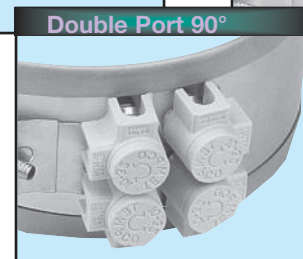
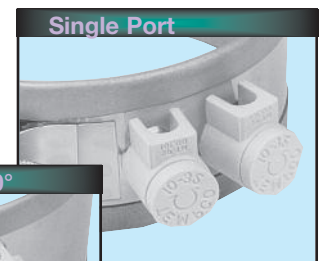
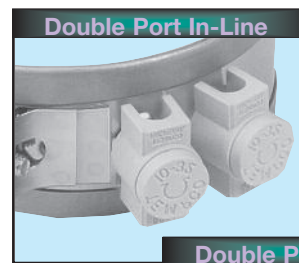

**Exposed electrical wiring on band heater installations is a violation of Electrical Safety Codes including O.S.H.A.**

## Terminations

### Low-Profile Button Terminals: Type B1, Type B2 & Type B3

Available on any clamping or construction variation, the specially designed Stainless Steel Button Terminals are internally connected to the heater and are resistant to over-torquing

while offering a low profile for tight spaces. They are virtually unbreakable. Secure tightening of the electrical connections is essential for safety and long heater life.

#### Duraband® Type B1 – Button Terminals

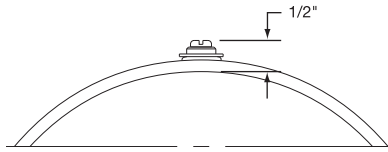

#### One-Piece Band

**Standard Termination Location:**  
each side of gap; center of width

- \* **Minimum Inside Diameter:** 2" (50.8 mm)
- \* **Minimum Width:** 1-1/2" (38.1 mm)
- \* **Screw Size:** 10-32 standard except 6-32 on IDs < 5"
- \* **Maximum Volts:** 480VAC
- \* **Maximum Amps:** 25A (10-32) or 20A (6-32)

#### Two-Piece Band

**Standard Termination Location:**  
next to gaps on each half;  
center of width

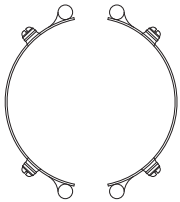

- \* **Minimum Inside Diameter:** 2" (50.8 mm)
- \* **Minimum Width:** 1-1/2" (38.1 mm)
- \* **Screw Size:** 10-32 standard except 6-32 on IDs < 5"
- \* **Maximum Volts/Amps:** 480VAC/ 25A (10-32) or 20A (6-32) each half

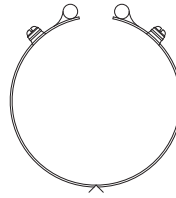

#### One-Piece Expandable Band

**Standard Termination Location:**  
each side of gap; center of width

- \* **Minimum Inside Diameter:** 2-1/2" (63.5 mm)
- \* **Minimum Width:** 1-1/2" (38.1 mm)
- \* **Screw Size:** 10-32 standard except 6-32 on IDs < 5"
- \* **Maximum Volts/Amps:** 480VAC/ 25A (10-32) or 20A (6-32)

#### Duraband Type B2 – Button Terminals

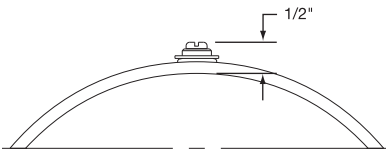

#### One-Piece Band

**Standard Termination Location:**  
next to gap; center of width

- \* **Minimum Inside Diameter:** 2" (50.8 mm)
- \* **Minimum Width:** 1-1/2" (38.1 mm)
- \* **Screw Size:** 10-32 standard except 6-32 on IDs < 5"
- \* **Maximum Volts:** 480VAC
- \* **Maximum Amps:** 25A (10-32) or 20A (6-32)

#### Two-Piece Band

**Standard Termination Location:**  
next to same gap on each half;  
center of width

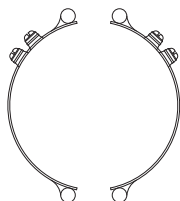

- \* **Minimum Inside Diameter:** 2" (50.8 mm)
- \* **Minimum Width:** 1-1/2" (38.1 mm)
- \* **Screw Size:** 10-32 standard except 6-32 on IDs < 5"
- \* **Maximum Volts/Amps:** 480VAC/ 25A (10-32) or 20A (6-32) each half

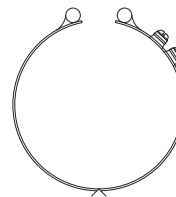

#### One-Piece Expandable Band

**Standard Termination Location:**  
next to gap; center of width

- \* **Minimum Inside Diameter:** 2-1/2" (63.5 mm)
- \* **Minimum Width:** 1-1/2" (38.1 mm)
- \* **Screw Size:** 10-32 standard except 6-32 on IDs < 5"
- \* **Maximum Volts/Amps:** 480VAC/ 25A (10-32) or 20A (6-32)

**View Product Inventory @ [www.tempco.com](http://www.tempco.com)**

### Duraband® Type B3 – Button Terminals

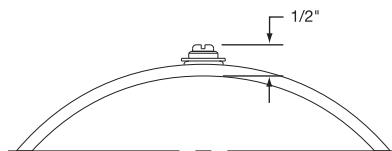

#### One-Piece Band

**Standard Termination Location:**  
next to gap; across center of width

- \* **Minimum Inside Diameter:** 2" (50.8 mm)
- \* **Minimum Width:** 2-3/8" (60.3 mm)
- \* **Screw Size:**  
10-32 standard except 6-32 on IDs < 5"
- \* **Maximum Volts:** 480VAC
- \* **Maximum Amps:** 25A (10-32) or 20A (6-32)

#### Two-Piece Band

**Standard Termination Location:**  
next to same gap on each half;  
across center of width

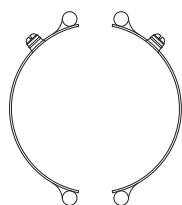

- \* **Minimum Inside Diameter:**  
2" (50.8 mm)
- \* **Minimum Width:** 2-3/8" (60.3 mm)
- \* **Screw Size:** 10-32 standard except  
6-32 on IDs < 5"
- \* **Maximum Volts/Amps:** 480VAC/  
25A (10-32) or 20A (6-32) each half

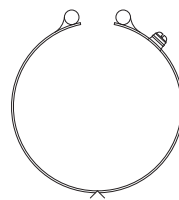

#### One-Piece Expandable Band

**Standard Termination Location:**  
next to gap; across center of width

- \* **Minimum Inside Diameter:**  
2-1/2" (63.5 mm)
- \* **Minimum Width:** 2-3/8" (60.3 mm)
- \* **Screw Size:** 10-32 standard except  
6-32 on IDs < 5"
- \* **Maximum Volts/Amps:** 480VAC/  
25A (10-32) or 20A (6-32)

### Plain Lead Wire Terminations: Type L1, Type L2 & Type L4

Available on any clamping or construction variation.

### Duraband Type L1 – Straight Lead Wires



The lead wires exit through a brass eyelet. The standard flexible leads are 10" long with 3" of fiberglass sleeving.

*If longer leads are required, specify when ordering.*



#### One-Piece Band

**Standard Termination Location:**  
next to gap; center of width

- \* **Minimum Inside Diameter:** 2" (50.8 mm)
- \* **Minimum Width:** 1" (25.4 mm)
- \* **Maximum Volts:** 480VAC
- \* **Maximum Amps:** 12.5A

#### Two-Piece Band

**Standard Termination Location:**  
next to same gap on each half;  
center of width

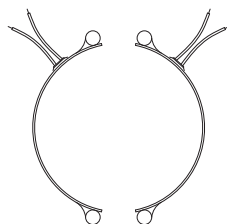

- \* **Minimum Inside Diameter:**  
2" (50.8 mm)
- \* **Minimum Width:** 1" (25.4 mm)
- \* **Maximum Volts:** 480V each half
- \* **Maximum Amps:** 12.5A each half

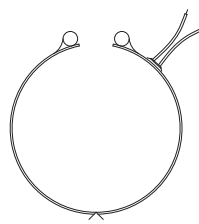

#### One-Piece Expandable Band

**Standard Termination Location:**  
next to gap; center of width

- \* **Minimum Inside Diameter:**  
2-1/2" (63.5 mm)
- \* **Minimum Width:** 1-1/4" (31.8 mm)
- \* **Maximum Volts:** 480V
- \* **Maximum Amps:** 12.5A

**CONTINUED**

## Terminations

### Duraband® Type L2 – Lead Wires

Continued from previous page...

L2 is the preferred termination on all small diameter and small width band heaters. The standard flexible leads are 10" long with 3" of fiberglass sleeving.

*If longer leads are required, specify when ordering.*



#### One-Piece Band

**Standard Termination Location:**  
each side of gap; edge of width

- \* Minimum Inside Diameter: 7/8" (22.2 mm)
- \* Minimum Width: 3/4" (19.1 mm)
- \* Maximum Volts: 480VAC
- \* Maximum Amps: 12.5A

#### Two-Piece Band

**Standard Termination Location:**  
each side of each gap;  
edge of width

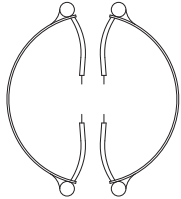

- \* Minimum Inside Diameter: 2" (50.8 mm)
- \* Minimum Width: 3/4" (19.1 mm)
- \* Maximum Volts: 480V each half
- \* Maximum Amps: 12.5A each half

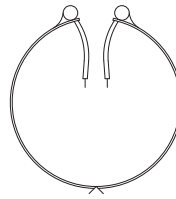

#### One-Piece Expandable Band

**Standard Termination Location:**  
each side of gap;  
edge of width

- \* Minimum Inside Diameter: 2-1/2" (63.5 mm)
- \* Minimum Width: 1-1/4" (31.8 mm)
- \* Maximum Volts: 480V
- \* Maximum Amps: 12.5A

### Duraband Type L4 – Lead Wires

L4 is a suitable lead termination for small band heaters. The standard flexible leads are 10" long with 3" of fiberglass sleeving.

*If longer leads are required, specify when ordering.*



#### One-Piece Band

**Standard Termination Location:**  
same side of gap; edge of width

- \* Minimum Inside Diameter: 7/8" (22.2 mm)
- \* Minimum Width: 1" (25.4 mm)
- \* Maximum Volts: 480VAC
- \* Maximum Amps: 12.5A

#### Two-Piece Band

**Standard Termination Location:**  
each side of same gap;  
center of width

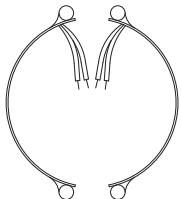

- \* Minimum Inside Diameter: 2" (50.8 mm)
- \* Minimum Width: 1" (25.4 mm)
- \* Maximum Volts: 480V each half
- \* Maximum Amps: 12.5A each half

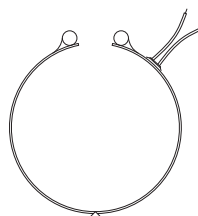

#### One-Piece Expandable Band

**Standard Termination Location:**  
same side of gap; edge of width

- \* Minimum Inside Diameter: 2-1/2" (63.5 mm)
- \* Minimum Width: 1-1/4" (31.8 mm)
- \* Maximum Volts: 480VAC
- \* Maximum Amps: 12.5A

### Abrasion Resistant Lead Terminations:

#### Type W1, Type W2, Type W2M, Type W3, Type W4 & Type W5M

Available on any clamping or construction variation.  
Wire braid leads offer sharp bending not possible with armor cable.

### Duraband® Type W1 & W1T – Straight Wire Braid Leads

**Type W1** – Braided lead wire crimped in place for heaters under 2-1/2" I.D. and/or under 1-1/4" width.

**Type W1T** – Braided lead wire attached with a threaded fitting for heaters over/equal 2-1/2" I.D. and over/equal 1-1/4" width.

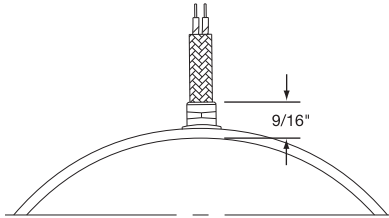

The standard leads are 10" of wire braid over 12" of flexible leads.

*If longer leads are required, specify when ordering.*

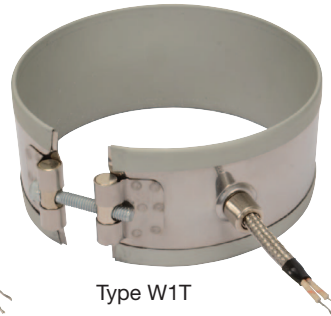
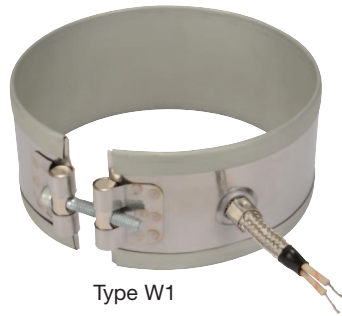

#### One-Piece Band

**Standard Termination Location:**  
next to gap; center of width

\* **Minimum Inside Diameter:**  
2" (50.8 mm)

\* **Minimum Width:** 1" (25.4 mm)

\* **Maximum Volts:** 480VAC

\* **Maximum Amps:** 12.5A

#### Two-Piece Band

**Standard Termination Location:**  
next to same gap on each half;  
center of width

\* **Minimum Inside Diameter:**  
2" (50.8 mm)

\* **Minimum Width:** 1" (25.4 mm)

\* **Maximum Volts:** 480VAC each half

\* **Maximum Amps:** 12.5A each half

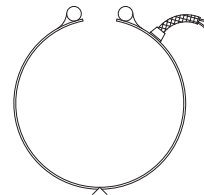
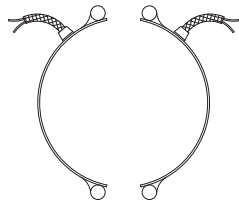

#### One-Piece Expandable Band

**Standard Termination Location:**  
next to gap; center of width

\* **Minimum Inside Diameter:**  
2-1/2" (63.5 mm)

\* **Minimum Width:** 1-1/4" (31.8 mm)

\* **Maximum Volts:** 480VAC

\* **Maximum Amps:** 12.5A

### Duraband Type W2 – Wire Braid Leads

The W2 wire braid exits at the middle of the segment on 1 and 2 piece designs and offset 1" from the middle of the segment for expandable designs. Sleeving is used for additional protection. The standard leads are 10" of wire braid over 12" of flexible leads with 3" of fiberglass sleeving.

*If longer leads are required, specify when ordering.*

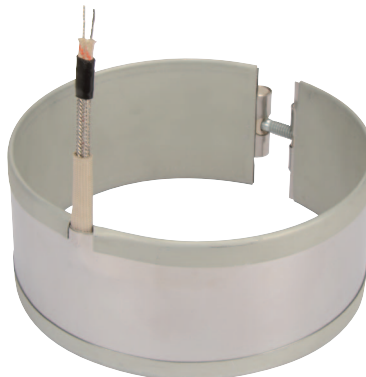

#### One-Piece Band

**Standard Termination Location:**  
opposite the gap; edge of width

\* **Minimum Inside Diameter:** 7/8" (22.2 mm)

\* **Minimum Width:** 1-1/8" (28.6 mm)

\* **Maximum Volts:** 480VAC

\* **Maximum Amps:** 12.5A

#### Two-Piece Band

**Standard Termination Location:**  
center of each half;  
edge of width

\* **Minimum Inside Diameter:**  
2" (50.8 mm)

\* **Minimum Width:** 1-1/8" (28.6 mm)

\* **Maximum Volts:** 480VAC each half

\* **Maximum Amps:** 12.5A each half

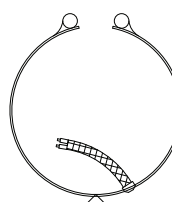
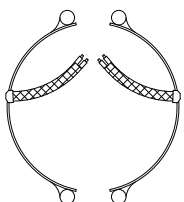

#### One-Piece Expandable Band

**Standard Termination Location:**  
opposite the gap offset 1";  
edge of width

\* **Minimum Inside Diameter:** 2-1/2" (63.5 mm)

\* **Minimum Width:** 1-1/8" (28.6 mm)

\* **Maximum Volts:** 480VAC

\* **Maximum Amps:**  
12.5A

**CONTINUED** →

## Terminations

### Duraband® Type W3 – Single Wire Braid Leads

Continued from previous page...

Highly recommended for nozzle heating applications. The standard leads are 10" of wire braid over 12" of flexible leads with 3" of fiberglass sleeving.

*If longer leads are required, specify when ordering.*

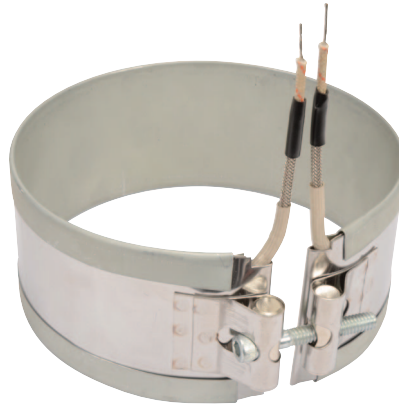

#### One-Piece Band

**Standard Termination Location:**  
each side of gap; edge of width

- \* **Minimum Inside Diameter:**  
3/4" (19.1 mm)
- \* **Minimum Width:** 7/8" (22.2 mm)
- \* **Maximum Volts:** 480VAC
- \* **Maximum Amps:** 12.5A

#### Two-Piece Band

**Standard Termination Location:**  
each side of each gap; edge of width

- \* **Minimum Inside Diameter:**  
2" (50.8 mm)
- \* **Minimum Width:** 3/4" (19.1 mm)
- \* **Maximum Volts:** 480VAC each half
- \* **Maximum Amps:** 12.5A each half

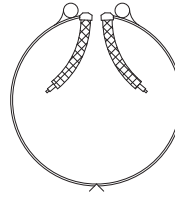
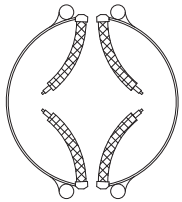

#### One-Piece Expandable Band

**Standard Termination Location:**  
each side of gap; edge of width

- \* **Minimum Inside Diameter:**  
2-1/2" (63.5 mm)
- \* **Minimum Width:** 1-1/4" (31.8 mm)
- \* **Maximum Volts:** 480VAC
- \* **Maximum Amps:** 12.5A

### Duraband Type W4 – Wire Braid Leads On One Side

A suitable termination for nozzle heating applications. The standard leads are 10" of wire braid over 12" of flexible leads.

*If longer leads are required, specify when ordering.*

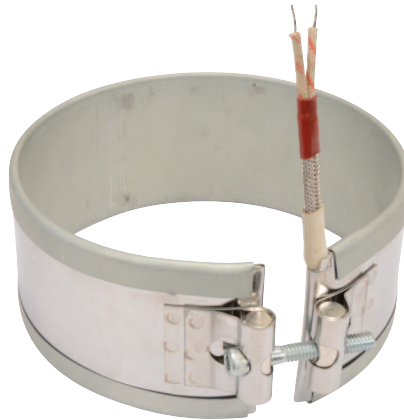

#### One-Piece Band

**Standard Termination Location:**  
next to gap; edge of width

- \* **Minimum Inside Diameter:**  
7/8" (22.2 mm)
- \* **Minimum Width:** 1" (25.4 mm)
- \* **Maximum Volts:** 480VAC
- \* **Maximum Amps:** 12.5A

#### Two-Piece Band

**Standard Termination Location:**  
next to same gap on each half;  
edge of width

- \* **Minimum Inside Diameter:**  
2" (50.8 mm)
- \* **Minimum Width:** 1" (25.4 mm)
- \* **Maximum Volts:** 480VAC each half
- \* **Maximum Amps:** 12.5A each half

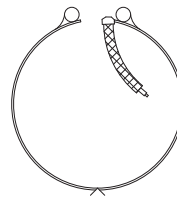
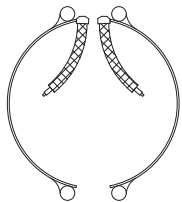

#### One-Piece Expandable Band

**Standard Termination Location:**  
next to gap; edge of width

- \* **Minimum Inside Diameter:**  
2-1/2" (63.5 mm)
- \* **Minimum Width:** 1-1/4" (31.8 mm)
- \* **Maximum Volts:** 480VAC
- \* **Maximum Amps:** 12.5A

### Duraband® Type W2M – Right-Angle Wire Braid Leads, 90° to Heater

Stainless Steel Wire Braid exits perpendicular to the heater centerline through a low profile stainless steel cap. This cap acts as a strain relief which protects against excessive flexing or pulling of the lead wire. The standard leads are 10" of wire braid over 12" of flexible leads.

*If longer leads are required, specify when ordering.*



**Note:** Stainless steel construction may be required for widths of 7/8" (22.2 mm) to 1-5/8" (41.3 mm).

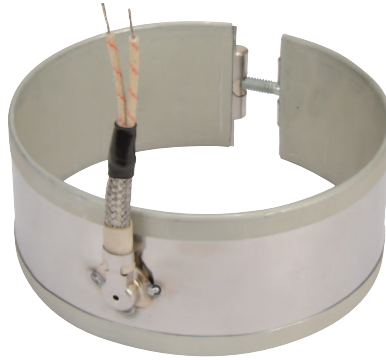

#### One-Piece Band

**Standard Termination Location:** opposite of gap; center of width

- \* **Minimum Inside Diameter:** 1-1/2" (38.1 mm)
- \* **Minimum Width:** 1-1/4" (31.8 mm)
- \* **Maximum Volts:** 480VAC
- \* **Maximum Amps:** 12.5A

#### Two-Piece Band

**Standard Termination Location:** next to same gap on each half; center of width

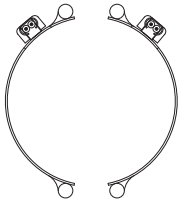

- \* **Minimum Inside Diameter:** 2" (50.8 mm)
- \* **Minimum Width:** 1-1/4" (31.8 mm)
- \* **Maximum Volts:** 480VAC each half
- \* **Maximum Amps:** 12.5A each half



#### One-Piece Expandable Band

**Standard Termination Location:** next to gap; center of width

- \* **Minimum Inside Diameter:** 2-1/2" (63.5 mm)
- \* **Minimum Width:** 1-1/4" (31.8 mm)
- \* **Maximum Volts:** 480VAC
- \* **Maximum Amps:** 12.5A

### Duraband Type W5M – Right-Angle Wire Braid Leads, Parallel to Heater

Stainless Steel Wire Braid exits parallel to the heater centerline through a low profile stainless steel cap. This cap acts as a strain relief which protects against excessive flexing or pulling of the lead wire. The standard leads are 10" of wire braid over 12" of flexible leads.

*If longer leads are required, specify when ordering.*



**Note:** Stainless steel construction may be required for widths of 7/8" (22.2 mm) to 1-5/8" (41.3 mm).

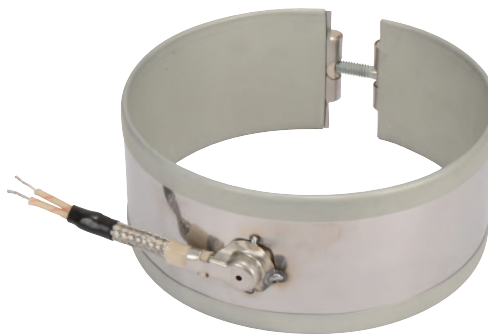

#### Selection

## TERMINATION

#### Guide

#### One-Piece Band

**Standard Termination Location:** opposite of gap; center of width

- \* **Minimum Inside Diameter:** 1-1/2" (38.1 mm)
- \* **Minimum Width:** 1-1/4" (31.8 mm)
- \* **Maximum Volts:** 480VAC
- \* **Maximum Amps:** 12.5A

#### Two-Piece Band

**Standard Termination Location:** next to same gap on each side; center of width

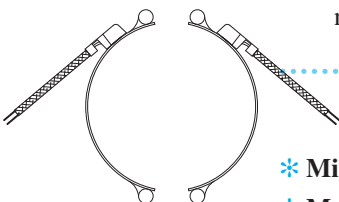

- \* **Minimum Inside Diameter:** 2" (50.8 mm)
- \* **Minimum Width:** 1-1/4" (31.8 mm)
- \* **Maximum Volts:** 480VAC each half
- \* **Maximum Amps:** 12.5A each half

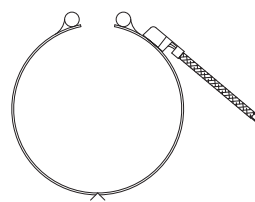

#### One-Piece Expandable Band

**Standard Termination Location:** next to gap; center of width

- \* **Minimum Inside Diameter:** 2-1/2" (63.5 mm)
- \* **Minimum Width:** 1-1/4" (31.8 mm)
- \* **Maximum Volts:** 480VAC
- \* **Maximum Amps:** 12.5A



## Terminations

### Armor Cable Terminations: Type R1, Type R2 & Type R3

Available on any clamping or construction variation. Armor cable provides far superior protection to lead wires where abrasion is a constant problem. The standard leads are 10" of armor cable over 12" of flexible leads.

*If longer leads are required, specify when ordering.*

### Duraband® Type R1 – Straight Armor Cable

**Type R1A** – Galvanized armor cable crimped in place for heaters under 2-1/2" I.D. and/or under 1-1/4" width.

**Type R1AT** – Galvanized armor cable attached with a threaded fitting for heaters over/equal 2-1/2" I.D. and over/equal 1-1/4" width.

**Type R1B** – Stainless Steel armor cable crimped in place for heaters under 2-1/2" I.D. and/or under 1-1/4" width.

**Type R1BT** – Stainless Steel armor cable attached with a threaded fitting for heaters over/equal 2-1/2" I.D. and over/equal 1-1/4" width.

**Type R1C** – Galvanized armor cable, tack welded

**Type R1D** – SS armor cable, tack welded

**Type R1E** – Galvanized armor cable, full silver brazing

**Type R1F** – SS armor cable, full silver brazing

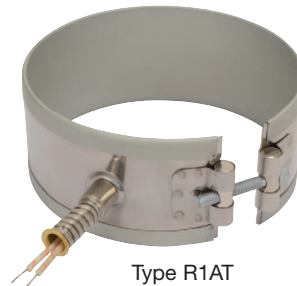
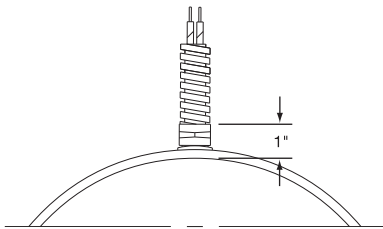

#### One-Piece Band

**Standard Termination Location:**  
next to gap; center of width

- \* **Minimum Inside Diameter:** 1-1/2" (38.1 mm)
- \* **Minimum Width:** 1" (25.4 mm)
- \* **Maximum Volts:** 480VAC
- \* **Maximum Amps:** 12.5A

#### Two-Piece Band

**Standard Termination Location:**  
next to same gap on each half;  
center of width

- \* **Minimum Inside Diameter:** 2" (50.8 mm)
- \* **Minimum Width:** 1" (25.4 mm)
- \* **Maximum Volts/Amps:** 480VAC/12.5A each half

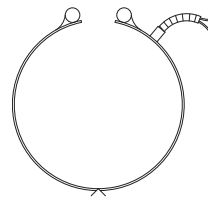
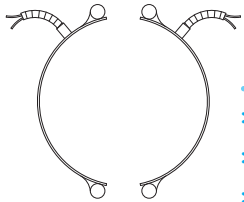

#### One-Piece Expandable Band

**Standard Termination Location:**  
next to gap; center of width

- \* **Minimum Inside Diameter:** 2-1/2" (65.3 mm)
- \* **Minimum Width:** 1-1/4" (31.8 mm)
- \* **Maximum Volts/Amps:** 480VAC/12.5A

### Duraband Type R2 – Right-Angle Armor Cable

**Type R2A** – Galvanized armor cable, crimped

**Type R2B** – SS armor cable, crimped

**Type R2C** – Plain leads, no cable

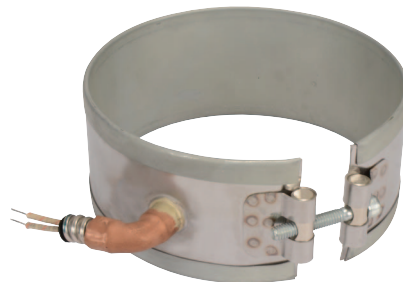
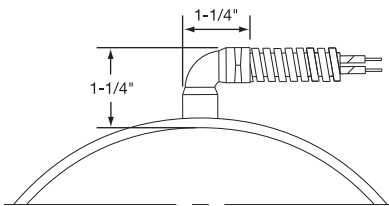

#### One-Piece Band

**Standard Termination Location:**  
next to gap; center of width

- \* **Minimum Inside Diameter:** 1-1/2" (38.1 mm)
- \* **Minimum Width:** 1-1/4" (31.8 mm)
- \* **Maximum Volts:** 480VAC
- \* **Maximum Amps:** 12.5A

#### Two-Piece Band

**Standard Termination Location:**  
next to same gap on each half;  
center of width

- \* **Minimum Inside Diameter:** 2" (50.8 mm)
- \* **Minimum Width:** 1-1/4" (31.8 mm)
- \* **Maximum Volts/Amps:** 480VAC/12.5A each half

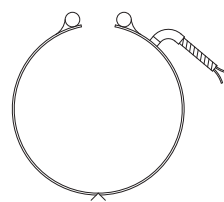
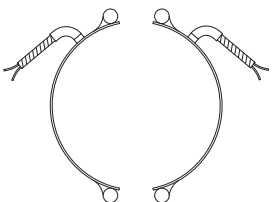

#### One-Piece Expandable Band

**Standard Termination Location:**  
next to gap; center of width

- \* **Minimum Inside Diameter:** 2-1/2" (63.5 mm)
- \* **Minimum Width:** 1-1/4" (31.8 mm)
- \* **Maximum Volts/Amps:** 480VAC/12.5A

### Duraband® Type R3 – Removable Armor Cable

**Type R3A** – Plain Leads & Female Fitting

**Type R3B** – Leads, Male Adapter & Galvanized Armor

**Type R3C** – Leads, Male Adapter & SS Armor

Recommended on applications where removable armor is required. The fitting will accept the standard armor cable connector. The standard leads are 10" of armor cable over 12" of flexible leads.

*If longer leads are required, specify when ordering.*

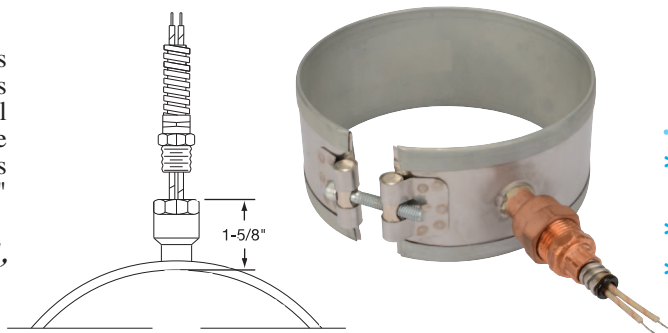

#### One-Piece Band

**Standard Termination Location:** next to gap; center of width

- \* **Minimum Inside Diameter:** 1-1/2" (38.1 mm)
- \* **Minimum Width:** 1-1/4" (31.7 mm)
- \* **Maximum Volts/Amps:** 480VAC/12.5A

#### Two-Piece Band

**Standard Termination Location:** next to same gap on each half; center of width

- \* **Minimum Inside Diameter:** 2" (50.8 mm)
- \* **Minimum Width:** 1-1/4" (31.7 mm)
- \* **Maximum Volts/Amps:** 480VAC/12.5A each half

#### One-Piece Expandable Band

**Standard Termination Location:** next to gap; center of width

- \* **Minimum Inside Diameter:** 2-1/2" (63.5 mm)
- \* **Minimum Width:** 1-1/4" (31.8 mm)
- \* **Maximum Volts/Amps:** 480VAC/12.5A

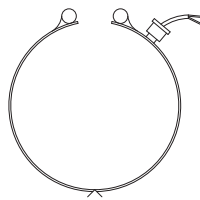
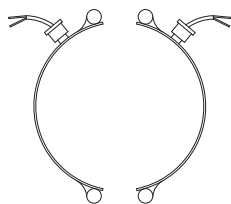

### Duraband Type S1 – Lead Wire Spring Strain Relief

A strain relief spring is attached to the heater at the termination exit to reduce strain on leads subjected to excessive flexing. The spring is 2-1/8" long. The flexible standard leads are 10" long with 3" of fiberglass sleeving. *If longer leads are required, specify when ordering.*

**Type S1A** – Plain Leads and Strain Relief Spring crimped in place for heaters under 2-1/2" I.D. and/or under 1-1/4" width.

**Type S1AT** – Plain Leads and Strain Relief Spring attached with a threaded fitting for heaters over/equal 2-1/2" I.D. and over/equal 1-1/4" width.

**Type S1B** – Stainless Steel Wire Braided Leads and Strain Relief Spring crimped in place for heaters under 2-1/2" I.D. and/or under 1-1/4" width 10" of braid over 12" of flexible leads is standard.

**Type S1BT** – Stainless Steel Wire Braided Leads and Strain Relief Spring attached with a threaded fitting for heaters over/equal 2-1/2" I.D. and over/equal 1-1/4" width. 10" of braid over 12" of flexible leads is standard.



#### One-Piece Band

**Standard Termination Location:** next to gap; center of width

- \* **Minimum Inside Diameter:** 2" (50.8 mm)
- \* **Minimum Width:** 1-1/4" (31.8 mm)
- \* **Maximum Volts:** 480VAC
- \* **Maximum Amps:** 12.5A

#### Two-Piece Band

**Standard Termination Location:** next to same gap on each half; center of width

- \* **Minimum Inside Diameter:** 2" (50.8 mm)
- \* **Minimum Width:** 1-1/4" (31.75 mm)
- \* **Maximum Volts/Amps:** 480VAC/12.5A each half

#### One-Piece Expandable Band

**Standard Termination Location:** next to gap; center of width

- \* **Minimum Inside Diameter:** 2-1/2" (63.5 mm)
- \* **Minimum Width:** 1-1/4" (31.75 mm)
- \* **Maximum Volts/Amps:** 480VAC/12.5A

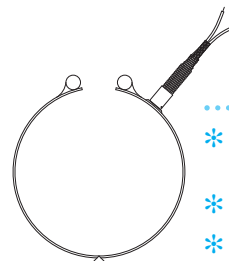
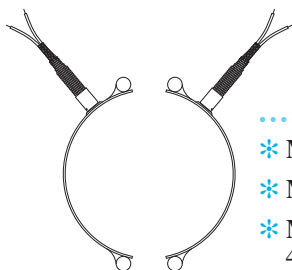

## Terminations

### General Purpose Terminal Boxes: Type C2 and Type C5

Available with any construction or clamping variation. They are a simple & economical way to protect employees from electric shock or prevent electric shorts that can result from exposed wiring on band heater electrical installations.

The Heavy Duty Terminal Boxes have 1/2" knockouts that will accept standard armor cable connectors. They can be field assembled on band heaters that have a center distance between terminal

screws of 7/8". Boxes can be pre-wired with galvanized armor, stainless steel armor, wire braid or plain leads. If a Low Profile Box with cable or leads is required, it is strongly recommended to order it pre-wired by the factory.

The standard leads are 10" of cable or wire braid over 12" of flexible leads. *If longer leads are required, specify when ordering.*

### Duraband® Type C2 – Standard Terminal Boxes



#### One-Piece Band

**Standard Termination Location:**  
next to gap; center of width

- \* **Minimum Inside Diameter:** 2-1/2" (63.5 mm)
- \* **Minimum Width:** 1" (25.4 mm) Heater widths between 1" and 2-1/2" require a minimum ID of 5-1/2" or greater.
- \* **Maximum Volts/Amps:** 480VAC/25A

#### Type C2 □ – Standard Box

- C2A** – Box only
- C2B** – w/galvanized armor
- C2C** – w/stainless steel armor
- C2D** – w/wire braid

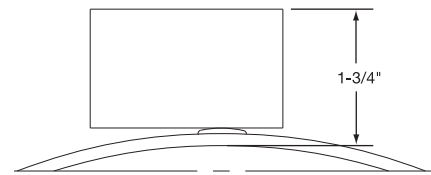

#### Two-Piece Band

**Standard Termination Location:**

next to same gap on each half; center of width

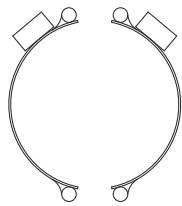

- \* **Minimum Inside Diameter:** 3" (76.2 mm)
- \* **Minimum Width:** 1" (25.4 mm) Heater widths between 1" and 2-1/2" require a minimum ID of 5-1/2" or greater.
- \* **Max. Volts/Amps:** 480VAC/25A each half

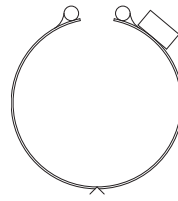

#### One-Piece Expandable Band

**Standard Termination Location:**  
next to gap; center of width

- \* **Minimum Inside Diameter:** 2-1/2" (63.5 mm)
- \* **Minimum Width:** 1" (25.4 mm) Heater widths between 1" and 2-1/2" require a minimum ID of 5-1/2" or greater.
- \* **Maximum Volts/Amps:** 480VAC/25A

### Duraband Type C5 – Low Profile Terminal Boxes



#### One-Piece Band

**Standard Termination Location:**  
next to gap; center of width

- \* **Minimum Inside Diameter:** 2-1/2" (63.5 mm)
- \* **Minimum Width:** 1" (25.4 mm) Heater widths between 1" and 2-1/2" require a minimum ID of 5-1/2" or greater.
- \* **Maximum Volts/Amps:** 480VAC/25A

#### Type C5 □ – Low Profile Box

- C5A** – box only
- C5B** – w/galvanized armor
- C5C** – w/SS armor
- C5D** – w/wire braid
- C5J** – w/plain leads

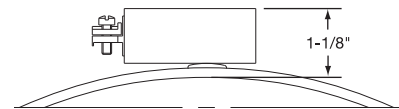

#### Two-Piece Band

**Standard Termination Location:**

next to same gap on each half; center of width

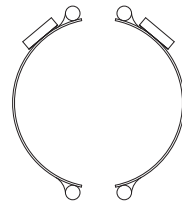

- \* **Minimum Inside Diameter:** 3" (76.2 mm)
- \* **Minimum Width:** 1" (25.4 mm) Heater widths between 1" and 2-1/2" require a minimum ID of 5-1/2" or greater.
- \* **Max. Volts/Amps:** 480VAC/25A each half

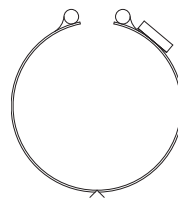

#### One-Piece Expandable Band

**Standard Termination Location:**  
next to gap; center of width

- \* **Minimum Inside Diameter:** 2-1/2" (63.5 mm)
- \* **Minimum Width:** 1" (25.4 mm) Heater widths between 1" and 2-1/2" require a minimum ID of 5-1/2" or greater
- \* **Maximum Volts/Amps:** 480VAC/25A

### Quick Disconnect Plugs: Type P1, Type P2, Type P3 and Type P4

Available on any construction or clamping variation. These plug assemblies are highly recommended & should be used whenever possible. The combination of plug & cup assembly along with armor cable covered leads eliminates all live exposed terminals or wiring that can be a potential hazard to employees or machinery.

Type P1 and P3 assemblies are available with a straight or right-

angle plug. Type P2 and P4 plug assemblies have a lower profile and are available with a straight plug only.

To simplify installation, band heaters with these assemblies can be supplied pre-wired, using high temperature lead wires.

The standard leads are 10" of armor cable over 12" of flexible leads. *If longer leads are required, specify when ordering.*

### Duraband® Type P1 – Quick Disconnect Plugs

#### Type P1 □

**P1K** – Cup assembly only

**P1L** – w/straight plug only

**P1M** – w/90° plug only

**P1N** – w/str. plug & galvanized cable

**P1O** – w/str. plug & SS cable

**P1P** – w/str. plug & wire braid

**P1Q** – w/90° plug & galvanized cable

**P1R** – w/90° plug & SS cable

**P1S** – w/90° plug & wire braid

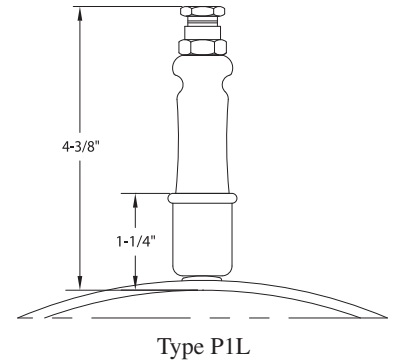
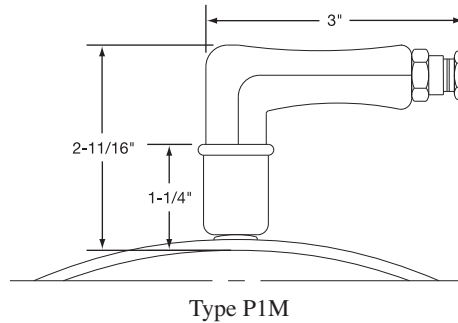

#### Plug Electrical Ratings

- \* 2-Pole 3-Wire Grounding
- \* Maximum Volts: 250 VAC
- \* Maximum Amps: 16A
- \* Maximum Temperature: 392°F (200°C)

#### One-Piece Band

**Standard Termination Location:**  
next to gap; center of width

- \* **Minimum Inside Diameter:** 2" (50.8 mm)
- \* **Minimum Width:** 1-1/2" (38.1 mm)  
If width is between 1-1/2" and 2",  
minimum diameter is 5-1/2".  
If width is greater than 2", minimum  
diameter is 2".

Type P1Q shown



#### Two-Piece Band

**Standard Termination Location:**  
next to same gap on each half;  
center of width

- \* **Minimum Inside Diameter:** 2" (50.8 mm)
- \* **Minimum Width:** 1-1/2" (38.1)  
If width is between 1-1/2" and 2",  
minimum diameter is 5-1/2".  
If width is greater than 2", minimum  
diameter is 2".

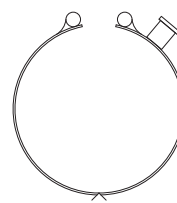
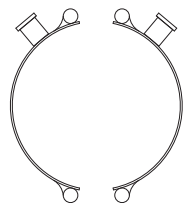

#### One-Piece Expandable Band

**Standard Termination Location:**  
next to gap; center of width

- \* **Minimum Inside Diameter:**  
2-1/2" (63.5 mm)
- \* **Minimum Width:** 1-1/2" (38.1 mm)  
If width is between 1-1/2" and 2",  
minimum diameter is 5-1/2".  
If width is greater than 2", minimum  
diameter is 2".



## Terminations

### Duraband® Type P2 – Quick Disconnect Plugs

Continued from previous page...

#### Type P2 □ – Low Profile Assembly

- P2F** – Low profile assembly only
- P2G** – w/straight plug only
- P2H** – w/str. plug and galvanized cable
- P2J** – w/str. plug and SS cable
- P2K** – w/str. plug and wire braid

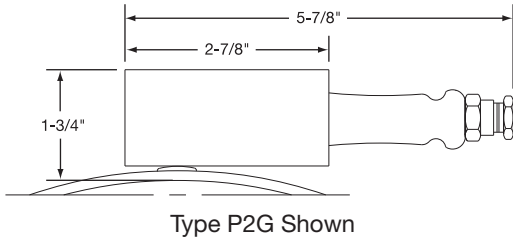

#### One-Piece Band

**Standard Termination Location:**  
next to gap; center of width

- \* **Minimum Inside Diameter:** 3" (76.2 mm)
- \* **Minimum Width:** 2-1/2" (63.5 mm)

#### Plug Electrical Ratings

- \* **2-Pole 3-Wire Grounding**
- \* **Maximum Volts:** 250 VAC
- \* **Maximum Amps:** 16A
- \* **Maximum Temperature:** 392°F (200°C)

#### Two-Piece Band

**Standard Termination Location:**  
next to same gap on each half;  
center of width

- \* **Minimum Inside Diameter:** 3" (76.2 mm)
- \* **Minimum Width:** 2-1/2" (63.5 mm)

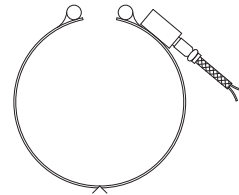
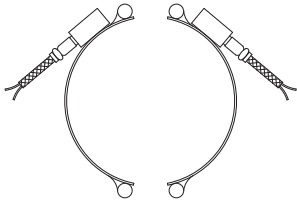

#### One-Piece Expandable Band

**Standard Termination Location:**  
next to gap; center of width

- \* **Minimum Inside Diameter:** 3" (76.2 mm)
- \* **Minimum Width:** 2-1/2" (63.5 mm)

### Duraband Type P3 – DIN 49458 A/B Quick Disconnect Plugs

#### One-Piece Band

**Standard Termination Location:**  
next to gap; center of width

- \* **Minimum Inside Diameter:** 3" (76.2 mm)
- \* **Minimum Width:** 1-1/2" (38.1 mm)

#### Plug Electrical Ratings

- \* **2-Pole 3-Wire Grounding**
- \* **Maximum Volts:** 250 VAC
- \* **Maximum Amps:** 16A
- \* **Maximum Temperature:** 392°F (200°C)

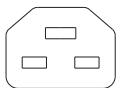

Standard Pin Orientation



#### Type P3 □ – Vertical Box Assembly

- P3A** – Box assembly only
- P3B** – Box assembly w/straight plug
- P3C** – Box assembly w/right-angle plug only

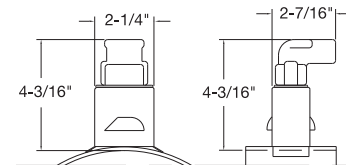

#### Two-Piece Band

**Standard Termination Location:**  
next to same gap on each half;  
center of width

- \* **Minimum Inside Diameter:** 3" (76.2 mm)
- \* **Minimum Width:** 1-1/2" (38.1 mm)

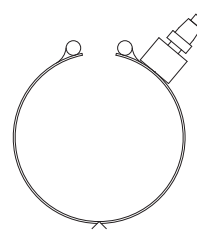
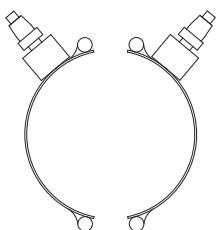

#### One-Piece Expandable Band

**Standard Termination Location:**  
next to gap; center of width

- \* **Minimum Inside Diameter:** 3" (76.2 mm)
- \* **Minimum Width:** 1-1/2" (38.1 mm)

### Duraband® Type P4 – DIN 49458 A/B Quick Disconnect Plugs

#### Type P4 □ – Horizontal Box Assembly

**P4A** – Box assembly only

**P4B** – Box assembly with straight plug

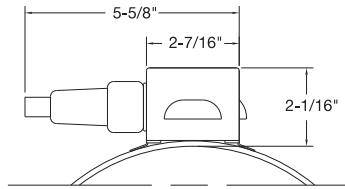

#### Plug Electrical Ratings

- \* 2-Pole 3-Wire Grounding
- \* Maximum Volts: 250 VAC
- \* Maximum Amps: 16A
- \* Maximum Temperature: 392°F (200°C)

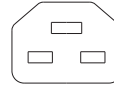

Standard Pin Orientation



Type P4C shown

#### One-Piece Band

**Standard Termination Location:**  
next to gap; center of width

- \* Minimum Inside Diameter: 3" (76.2 mm)
- \* Minimum Width: 2-1/2" (63.5 mm)

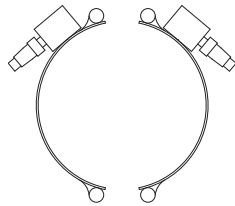

#### Two-Piece Band

**Standard Termination Location:**  
next to same gap on each half;  
center of width

- \* Minimum Inside Diameter: 3" (76.2 mm)
- \* Minimum Width: 2-1/2" (63.5 mm)

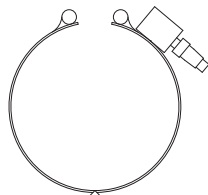

#### One-Piece Expandable Band

**Standard Termination Location:**  
next to gap; center of width

- \* Minimum Inside Diameter: 3" (76.2 mm)
- \* Minimum Width: 2-1/2" (63.5 mm)

### Special Duraband® Construction Options

#### Thermocouple Bayonet Adapter

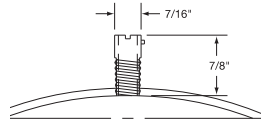

A standard Bayonet Adapter facilitates the installation of an external thermocouple with a standard bayonet cap. The standard location for the adapter is 90° from the gap. Specify without through hole for heater sensing or with through hole for load sensing. For heaters less than 1" wide order separate strap clamping and utilize the gap for the thermocouple.

Refer to pages 14-3 and 14-4 for a complete selection of thermocouples available from stock.

#### Thermocouple Coupling

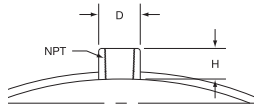

The Thermocouple Coupling facilitates the installation of an external thermocouple with a threaded fitting to sense the temperature of the band. The standard location for the coupling is 90° from the gap. Specify without through hole for heater sensing or with through hole for load sensing.

#### Available Bushing Sizes:

Thread	D	H
1/8-27 NPT	9/16"	5/8"
1/4-18 NPT	3/4"	11/16"
3/8-18 NPT	7/8"	5/8"
M12-1.75 mm	3/4"	1/2"



#### Holes and Cutouts

Holes and cutouts are normally required in band heaters for clearance for thermocouple probes or holding bolts. An oversize gap can in many cases serve the same purpose, saving the expense of the hole.

Using the center of the gap as a starting point, specify the location of the center-point of the hole or cutout in terms of degrees and the distance from the edge of the heater. In addition, state the size of the hole or cutout.

For critical hole and cutout locations, a detailed drawing will be required.



**Note:** A minimum of 1/2" is required from the hole to the edge of the heater.

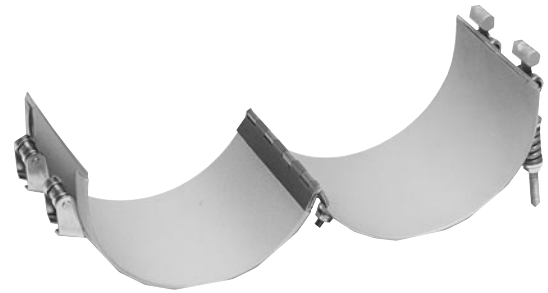

#### Hinged Two-Piece Band

The Hinged Two-Piece Band Heater is connected with a continuous hinge for easy installation and removal. This heater can be opened and closed as often as is necessary. The preferred method of clamping is latch and trunnion. It is available with any screw or lead variation. When ordering, specify watts and volts each half.

**Minimum Width:** 1-3/8" (34.9 mm)

### Special Mica Insulated Heater Construction Variations

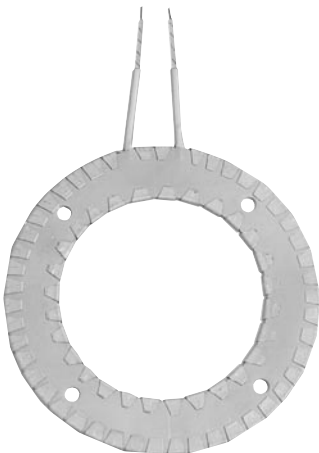

#### Ring Heaters

When ordering Ring Heaters, specify inside and outside diameters. If mounting holes are required, specify location and hole size. For critical hole and cutout locations, a detailed drawing will be required.

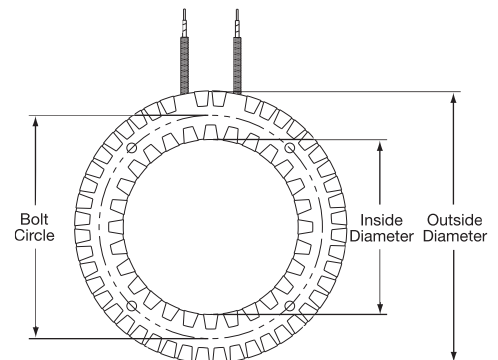

### Special Mica Insulated Heater Construction Variations (continued)

#### Square, Rectangular, or Hexagon Bands

**Square or Rectangular** band heaters are normally used for heating dies on plastic extruders, or the barrels of twin screw extruders. They can be made in either one- or two-piece construction but two-piece construction with **Style 1** Clamping (*see below*) is recommended.

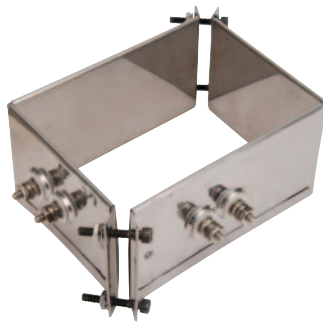

**Hexagon** shaped band heaters are used on the hex shaped portion of the nozzle on injection molding machines. These types of heaters are strictly made to customer specifications with bent-up flange clamping only.



**Clamping Styles** – Three clamping styles are used on square and rectangular band heaters:

**Style 1 for 2-piece heaters:** bent-up flange clamping at the corners provides the most uniform clamping force and should be used whenever possible.

**Maximum Recommended Watt Density:** 25 w/in<sup>2</sup>

**Style 2 for 2-piece heaters:** bent-up flange clamping or built-in strap brackets at the sides requires a minimum “B” dimension of 3.75” (95.3 mm).

**Maximum Recommended Watt Density:** 20 w/in<sup>2</sup>

**Style 3 for 1-piece heaters:** bent-up flange clamping or built-in strap brackets at the sides requires a minimum “A” dimension of 3.75” (95.3 mm).

**Maximum Recommended Watt Density:** 25 w/in<sup>2</sup>

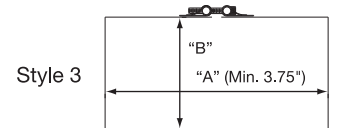
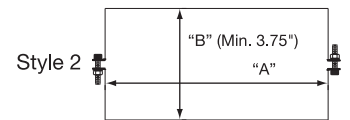
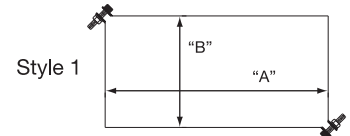

#### Ordering Information

- Square, Rectangular or Hex
- Select Clamping Style 1, 2 or 3
- Specify inside dimensions – Square or Rectangular: “A” and “B”  
Hexagon: Specify internal dimension across flats
- Width: Minimum 3/4” (19.1 mm)
- Wattage: per half on two-piece heaters
- Voltage: per half on two-piece heaters
- Termination (see pages 1-32 through 1-45)
- Lead Cable/Braid Length
- Special Features (see page 1-46)
- Provide drawing or sample part when possible

**⚠ WARNING:** Cancer and Reproductive Harm - [www.P65Warnings.ca.gov](http://www.P65Warnings.ca.gov).

#### Cone Shapes

Cone Shaped Heaters are normally used for special heating applications when heat is required for hoppers or funnels. They are made strictly to customer specifications. The preferred method of attachment is with built-in bracket clamping. When ordering or for quoting purposes, supply a detailed drawing or sample part. Include the top ID, bottom ID, and the vertical rise or heater width.

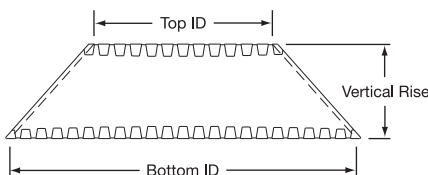



## Duraband Features

### Additional Duraband® Heater Features

#### Electrical Variations

**Three-Phase** On very high wattage band heaters it would be advantageous to set up the wiring three-phase to reduce the current load across a single conductor. Three-Phase wiring is available on select clamping/construction or termination variation (termination location is subject to engineering approval).

**Min. ID:** 3" (76.2 mm), **Min. Width:** 2" (50.8 mm)

**Dual Voltage** Band heaters can be designed using 3-wire series/parallel circuits for dual voltage applications. Whether the heater is run on the higher or lower voltage, the wattage will be the same. Dual Voltage wiring is available on any clamping/construction or termination variation.

#### Ground Terminal or Lead

For those applications requiring a separate ground terminal or lead attached to the heater sheath. A Ground Terminal or Lead is available on any clamping/construction or termination variation.

**Single Phase/Three Phase** Duraband Heaters can be designed with multiple circuits to operate single or three-phase.

#### Built-In Thermocouples

Heaters can be manufactured with a Built-In Thermocouple to closely control the temperature of the heater.

Type J or K thermocouples are available with fiberglass, wire braid or any other required insulation.

Consult Tempco with your requirements.

#### Construction Variations

**All Stainless Steel Construction** Mica band heaters can be constructed with the external sheath made entirely from stainless steel. This allows the Duraband to reach the maximum temperature of 1200°F (650°C). All Stainless Steel Construction is available on any clamping/construction or termination variation.

Other sheath materials, such as rust-resistant steel, Monel®, aluminum, or copper are also available for unique applications.

**Other Sheath Materials** Other sheath materials, such as rust-resistant steel, Monel®, aluminum, or copper are also available for unique applications.

CONSULT TEMPCO  
WITH YOUR REQUIREMENTS –  
WE HAVE THE RIGHT SOLUTIONS

#### Lead Variations

**Electrical Plugs** Industry standard NEMA Twist-Lock® electrical plugs are available. The plugs can be attached to fiberglass leads, armor cable or wire braid. Electrical Plugs can be added to any clamping/construction or termination variation.

See page 15-15 for additional Twist-Lock electrical plugs.

**Terminal Lugs** Various types of crimp terminals can be attached to the heater leads to make wiring into applications quick and easy. High temperature 1200°F (649°C) ring terminals and nylon or PVC insulated terminals are available. Spade, ring, and right-angle or straight quick disconnect type terminals can be attached to the leads.



Reference	NEMA P or R	Amps	Volts	Plug Part Number	Connectors (Female) Part Number
P4 twist lock	L5-15	15A	125V	EHD-102-113	EHD-103-104
P5 twist lock	L6-15	15A	250V	EHD-102-121	EHD-103-107
P9 twist lock	L2-20	20A	250V	EHD-102-104	N/A

### Ordering Information

#### Custom Engineered/Manufactured Heaters

Understanding that an electric heater can be very application specific, for sizes not listed **TEMPCO** will design and manufacture a Duraband Heater to meet your requirements. **Standard lead time is 2 weeks.**

**Please Specify** the following:

- Inside Diameter
- Width
- Wattage
- Voltage
- Quantity
- Termination (see pages 1-32 through 1-45)
- Lead Cable/Braid Length
- Construction style (see pages 1-28, 1-46 and 1-47)
- Clamping variation (see pages 1-29 through 1-31)
- Special Features

#### Stock Heaters

Order by Part number for stock heaters listed on pages 1-52 through 1-59.

**⚠ WARNING:** Cancer and Reproductive Harm - [www.P65Warnings.ca.gov](http://www.P65Warnings.ca.gov).

### Duraband® and Mica Insulated Heater Special Custom Designs

**Variety and Versatility in Mica Insulated Heaters.** No other heater band has the design and manufacturing flexibility of mica insulated heaters. Tempco's flexible CNC sheet metal fabricating machines, custom developed engineering programs with built-in intelligence, and experienced and talented engineering staff allow us to push the limits on band heater designs.

Throughout our catalog we show Tempco's standard specifications and most popular designs. However, as a custom heating element manufacturer, we recognize that many applications require non-standard and unique designs.

At Tempco, we are constantly challenged by our customers to solve their heating applications. We have the experience, technical knowledge and manufacturing capability to solve all your heating problems with unique heater designs. You should use

Tempco's talent and capabilities to your benefit to solve your specific heating problem in an expeditious and cost effective manner.

*The following pictures* show some of the heater designs that we have developed for special applications. Next time, when you have a special application and you want someone to work with you and "think outside the box" to solve your specific heating application, call Tempco.

We haven't seen all heating applications, but most likely our experienced staff has seen and solved more heating problems than you have seen.

*Use our knowledge and experience to work for you. Challenge us! You will be glad you did.*

*We Welcome Your Inquiries.*

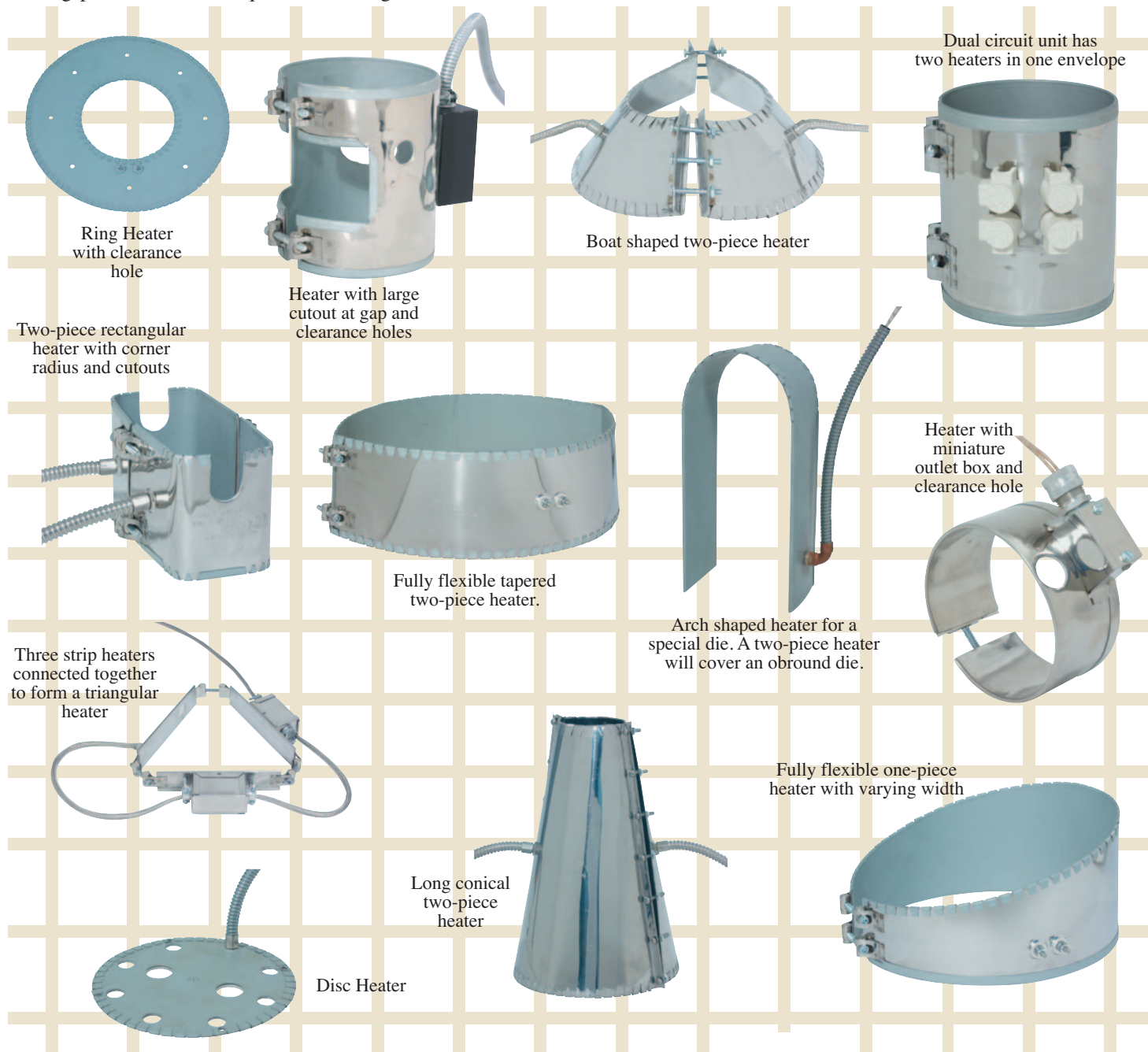

### ***“Sinuated” Element Construction for Commercial OEM Applications***



An alternative to wound ribbon core heaters is the sinuated heater element. In this type of construction, the heating element resistance wire is sinuated, or “formed” back and forth without a middle core layer of mica insulation. The heating element is then sandwiched between two layers of specially selected mica insulation to provide excellent thermal conductivity and dielectric strength.

The sinuated formed element lends itself to lower temperature and watt density applications where high watt density construction is not required.

#### **Typical Applications (Cylindrical Surfaces)**

- *Food and Candy Extruders*
- *Vending Machines*
- *Commercial Food Equipment*
- *Food Service Warming Items*
- *Laboratory and Scientific Apparatus*
- *Photographic Equipment*
- *Incubators*

***The Solution for Low to Medium Temperature Cylindrical and Flat Surface Heating Applications***

#### **Typical Applications (Flat Surfaces)**

- *Laminating*
- *Food Service Warming Items*
- *Radiant Heating*
- *Incubators*



This design is widely used in food service and the farming industry. By careful selection of economical materials used for these low temperature applications, significant cost savings can be realized compared to standard mica heaters.

*Contact Tempco for Complete Product Details.*

## Installation

## RECOMMENDATIONS

1. Disconnect electric power to the machine and/or heaters prior to installing or replacing heaters.
2. Do not install heaters in areas where combustible gases, vapor or dust is present.
3. Use as many narrow band heaters as the application will permit. 1-1/2" through 3" wide heaters are recommended.
4. Using a heater that closely matches the wattage requirements will decrease the frequency of cycling and temperature overshoot, thereby increasing the life of the heater.
5. Make certain that all barrel surfaces are clean and have a smooth finish. Any contaminants or imperfections on the surface can cause premature heater failure.
6. Tempco expandable type Mica Band Heaters may be opened once at the gap to fit on the barrel. Do not open these heaters beyond their specified heater diameter.



*Do not open Tempco One-Piece Non-Expandable Type mica band Heaters. Opening of these heaters can damage Mica Insulation and will create electrical short circuits.*

7. Position heater bands on the barrel.
8. Securely tighten heater bands around the barrel. Clamping force must be equally distributed on heaters with more than one set of clamping brackets.

*Recommended clamping bolt torque is 50-60 in./lbs.*

9. For heaters with screw terminals, remove the top nut and flat washers from the power screw terminals. Do not remove or loosen the bottom nut on the power screw terminals. The bottom nut is pretorqued at our factory. A loose bottom nut will create an internal high resistance connection and will result in premature heater failure.
10. All electrical wiring of heater bands should be done by a qualified electrician.
  - a. Use only Stainless Steel or other high temperature lugs to prevent material degradation when exposed to high temperatures over a prolonged period of time.



**DO NOT USE COPPER OR PLATED COPPER LUGS.**

### Installation Accessories Available

#### IMMEDIATE DELIVERY!

- \* High Temperature Terminal Lugs
- \* Igloo™ Ceramic Terminal Covers
- \* UL Listed Plugs
- \* High Temperature Lead Wire 842°F (450°C)
- \* Armor Cable
- \* Stainless Steel Braid
- \* High Temperature Sleaving
- \* High Temperature Mica Insulated Wiring Harnesses 842°F (450°C)
- \* Thermocouples
- \* Temperature Controllers
- \* High Temperature Fiberglass Tape

- b. Use an open ended wrench to hold bottom nut as the wiring nut is torqued.
- c. Heaters must be wired using the proper gauge wire with a minimum temperature rating of 842°F (450°C). All Duraband Heaters supplied with lead wire terminations or factory pre-wired screw terminals use mica insulated lead wires rated to 842°F (450°C).



**NEVER ALLOW LEAD WIRES TO LIE DIRECTLY ON THE HEATER SURFACE.**

- d. When connecting power leads to screw terminals make certain that barrels of terminal lugs are not facing down toward the heater case, which will create a short circuit.

*Recommended Screw Terminal Torque is 25 in./lbs.*

- e. Make certain power lead wires do not make contact with hot heater surfaces to avoid degradation of lead wire, as this can cause electrical short circuits.
- f. Make sure the voltage input to the heater bands does not exceed the voltage rating that is stamped on the heater band.
- g. It is recommended that an amperage reading is taken for each heater to verify proper wiring. (Amps = Watts/Volts)
11. Insulate all live electrical wires per applicable safety standards.
12. Begin heater band re-tightening procedure. Be sure to wear protective gloves.
  - a. Energize heater bands and allow the heater to reach 300°F (149°C). This usually takes between 3 and 5 minutes.
  - b. Turn off power and immediately re-tighten the heater bands to 10 ft./lbs. Turn power back on.
13. Install shrouds around the machine to meet applicable safety requirements.
14. Once installed, check surroundings to make sure that contaminants won't get on the heater while the unit is in operation. Accumulation of contaminants on heaters can cause premature heater failure.
15. Insulating blanket installations must have band heater retightening sequence (#12) completed before blanket installation. Lead wires must exit the insulation blanket as soon as possible; do not entrap lead wires between heater sheath and insulation blanket.



It is imperative that upon start-up of new machines at customer facilities, all of the aforementioned parameters are double checked by qualified field service personnel.

**Exposed electrical wiring on band heater installations is a violation of Electrical Safety Codes including O.S.H.A.**

### STOCK Replacement Band Heaters for Plastic Injection Molding Machines



**COST EFFECTIVE WITHOUT  
COMPROMISING QUALITY**

#### NHL Mica Insulated Nozzle Heater

ID in	Width in	Watts	Watt Density W/in <sup>2</sup>	Part Number	
				120V	240V
7/8	1	85	49	NHL00130	NHL00131
1	1	100	47	NHL00100	NHL00101
1	1	125	58	NHL00132	NHL00133
1	1½	150	47	NHL00102	NHL00103
1	1½	200	62	NHL00104	NHL00105
1	2	250	58	NHL00106	NHL00107
1¼	¾	100	55	NHL00154	NHL00155
1¼	1	175	60	NHL00108	NHL00109
1¼	1¼	125	34	NHL00156	NHL00157
1¼	1¼	250	68	NHL00158	NHL00159
1¼	1½	250	57	NHL00110	NHL00111
1½	¾	100	31	NHL00160	NHL00161
1½	1	100	27	NHL00162	NHL00163
1½	1	150	40	NHL00112	NHL00113
1½	1	200	54	NHL00114	NHL00115
1½	1¼	250	54	NHL00164	NHL00165
1½	1½	150	27	NHL00134	NHL00135
1½	1½	200	36	NHL00116	NHL00117
1½	1½	250	45	NHL00136	NHL00137
1½	1½	275	49	NHL00118	NHL00119
1½	1½	300	54	NHL00138	NHL00139
1½	2	300	40	NHL00120	NHL00121
1½	2½	350	38	NHL00122	NHL00123
1½	2½	400	43	NHL00166	NHL00167
1½	3	350	31	NHL00168	NHL00169
1½	3	400	36	NHL00124	NHL00125
1½	3	500	45	NHL00170	NHL00171
1¾	1	175	39	NHL00172	NHL00173
1¾	1½	200	30	NHL00174	NHL00175
1¾	1½	225	33	NHL00140	NHL00141
1¾	1½	250	37	NHL00176	NHL00177
1¾	1½	300	44	NHL00178	NHL00179
1¾	3	500	37	NHL00180	NHL00181
2	1	200	38	NHL00182	NHL00183
2	1½	300	38	NHL00142	NHL00143
2	2	400	38	NHL00144	NHL00145
2½	1	100	18	NHL00126	NHL00127
2½	2	200	18	NHL00128	NHL00129
2¼	1	225	37	NHL00146	NHL00147
2¾	1	250	39	NHL00148	NHL00149
2½	1	300	44	NHL00150	NHL00151
2½	1½	200	19	NHL00152	NHL00153
2½	1½	350	34	NHL00186	NHL00187

**In Stock!**

- \* Economically Priced
- \* Type NHL with 12" leads and 2" of protective sleeving
- \* Supplied with low profile clamping strap

All Items Available from Stock



**Note:** For normal plastic processing Tempco recommends Watt Densities under 55 W/in<sup>2</sup>.

### STOCK Replacement Band Heaters for Plastic Injection Molding Machines



**COST EFFECTIVE WITHOUT  
COMPROMISING QUALITY**

#### NHW Mica Insulated Nozzle Heater

ID in	Width in	Watts	Watt Density W/in <sup>2</sup>	Part Number	
				120V	240V
7/8	1	85	49	NHW00130	NHW00131
1	1	100	47	NHW00100	NHW00101
1	1	125	58	NHW00132	NHW00133
1	1½	150	47	NHW00102	NHW00103
1	1½	200	62	NHW00104	NHW00105
1	2	250	58	NHW00106	NHW00107
1¼	1	175	60	NHW00108	NHW00109
1¼	1¼	125	34	NHW00156	NHW00157
1¼	1¼	250	68	NHW00158	NHW00159
1¼	1½	250	57	NHW00110	NHW00111
1½	7/8	100	31	NHW00160	NHW00161
1½	1	100	27	NHW00162	NHW00163
1½	1	150	40	NHW00112	NHW00113
1½	1	200	54	NHW00114	NHW00115
1½	1¼	250	54	NHW00164	NHW00165
1½	1½	150	27	NHW00134	NHW00135
1½	1½	200	36	NHW00116	NHW00117
1½	1½	250	45	NHW00136	NHW00137
1½	1½	275	49	NHW00118	NHW00119
1½	1½	300	54	NHW00138	NHW00139
1½	2	300	40	NHW00120	NHW00121
1½	2½	350	38	NHW00122	NHW00123
1½	2½	400	43	NHW00166	NHW00167
1½	3	400	36	NHW00124	NHW00125
1½	3	500	45	NHW00170	NHW00171
1¾	1½	200	30	NHW00174	NHW00175
1¾	1½	225	33	NHW00140	NHW00141
1¾	1½	250	37	NHW00176	NHW00177
1¾	1½	300	44	NHW00178	NHW00179
2	1½	300	38	NHW00142	NHW00143
2	2	400	38	NHW00144	NHW00145
2⅞	1	100	18	NHW00126	NHW00127
2⅞	1	200	35	NHW00184	NHW00185
2⅞	2	200	18	NHW00128	NHW00129
2¼	1	225	37	NHW00146	NHW00147
2⅜	1	250	39	NHW00148	NHW00149
2½	1	300	44	NHW00150	NHW00151
2½	1½	200	19	NHW00152	NHW00153
2½	1½	350	34	NHW00186	NHW00187
2¾	1½	400	35	NHW00188	NHW00189

**In Stock!**

- \* Economically Priced
- \* Type NHW with 12" leads and 10" SS wire braid
- \* Supplied with low profile clamping strap

*All Items Available from Stock*

### Ordering Information

See page 1-48



**Note:** For normal plastic processing Tempco recommends Watt Densities under 55 W/in<sup>2</sup>.

# Band Heaters



## Duraband Nozzle Band Heaters

### Stock and Standard (Non-Stock) Replacement Mica Insulated Band Heaters for Plastic Injection Molding Machines

Stock Items Are Shown In **RED**



Fig. A

ID		Width		Wattage	Fig.	Tempco Part Number	
in	mm	in	mm			120V	240V
1¼	31.8	1¾	30.2	125	A	—	<b>MBH00033</b>
1½	38.1	1	25.4	150	A	<b>MBH00031</b>	MBH00035
1½	38.1	1	25.4	150	A	—	<b>MBH00036</b> ①
2⅝	58.7	1¾	36.5	300	A	—	MBH00038
2⅝	58.7	1¾	36.5	300	A	—	<b>MBH00039</b> ①

① Heaters have built-in Type J Thermocouple

Stock Items Are Shown In **RED**

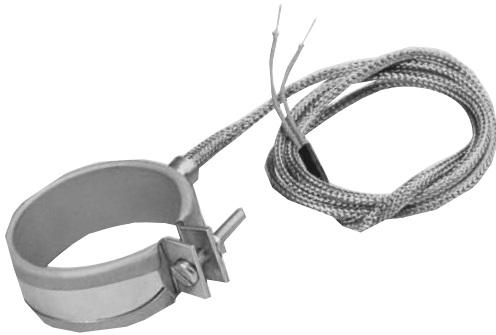

Fig. B

ID		Width		Wattage	Watt Density		Fig.	Part Number	
in	mm	in	mm		W/in <sup>2</sup>	W/cm <sup>2</sup>		120 Volts	240 Volts
1½	38.1	1	25.4	150	40	6.3	B	<b>MBH00030</b>	<b>MBH00034</b>
1¾	44.5	1	25.4	175	39	6.0	B	<b>MBH00003</b>	<b>MBH00012</b>
2	50.8	1	25.4	200	38	5.9	B	MBH00004	<b>MBH00013</b>
2¼	57.2	1	25.4	175	29	4.5	B	<b>MBH00005</b>	—
2¼	57.2	1½	38.1	300	33	5.1	B	—	<b>MBH00037</b>
2½	63.5	1	25.4	250	36	5.7	B	<b>MBH00006</b>	<b>MBH00014</b>
3	76.2	1	25.4	200	24	3.7	B	<b>MBH00007</b>	<b>MBH00015</b>
3½	88.9	1	25.4	300	30	4.7	B	MBH00009	<b>MBH00016</b>

Stock Items Are Shown In **RED**



Fig. C

ID		Width		Wattage	Watt Density		Fig.	Part Number
in	mm	in	mm		W/in <sup>2</sup>	W/cm <sup>2</sup>		240 V
1½	38.1	1½	38.1	275	49	7.7	C	<b>MBH00019</b>
1½	38.1	1¾	44.5	250	38	6.0	C	<b>MBH00020</b>
1½	38.1	2½	63.5	400	43	6.7	C	<b>MBH00021</b>
1½	38.1	3	76.2	450	40	6.3	C	<b>MBH00022</b>
1½	38.1	4½	114.3	600	36	5.6	C	<b>MBH00023</b>
1¾	44.5	6	152.4	800	30	4.6	C	<b>MBH00024</b>
2⅝	54.0	1⅝	23.8	215	40	6.3	C	MBH00025
2⅝	58.7	1⅝	23.8	260	44	6.9	C	MBH00026
2⅝	58.7	1⅝	34.9	240	28	4.3	C	<b>MBH00027</b>
2¼	69.9	1½	38.1	260	23	3.5	C	<b>MBH00028</b>

#### Design Features:

- \* All heaters have 24" high temperature leads with 22" stainless steel overbraid

### Ordering Information

See page 1-48

### Stock and Standard (Non-Stock) Mica Insulated Band Heaters for Plastic Injection Molding Machines

#### Design Features:

- \* All heaters have 24" high temperature leads with 22" stainless steel overbraid — **Type W3**
- \* Heaters less than 1-1/2" wide have separate straps — **Type SE**
- \* Designed as one-piece expandable type, enables you to open up the heater to the diameter of the barrel for easy installation.



#### Stock Items Are Shown In RED

ID		Width		Wattage	Watt Density		Style	Part Number		
in	mm	in	mm		W/in <sup>2</sup>	W/cm <sup>2</sup>		120V	240V	480V
2½	69.9	3½	88.9	600	22	3.5	NE	<b>MBH00040</b>	—	—
3	76.2	1	25.4	200	24	3.7	SE	<b>MBH00041</b>	<b>MBH00054</b>	—
3	76.2	1	25.4	250	30	4.7	SE	<b>MBH00042</b>	<b>MBH00055</b>	—
3	76.2	1	25.4	300	36	5.6	SE	<b>MBH00043</b>	MBH00056	—
3	76.2	1	25.4	400	48	7.4	SE	<b>MBH00044</b>	MBH00057	—
3	76.2	1½	38.1	500	40	6.1	NE	MBH00045	<b>MBH00058</b>	—
3	76.2	2½	63.5	300	14	2.2	NE	—	MBH00059	—
3½	88.9	¾	15.9	200	32	5.0	SE	<b>MBH00046</b>	<b>MBH00060</b>	—
3½	88.9	1	25.4	200	20	3.1	SE	<b>MBH00047</b>	—	—
3½	88.9	1½	38.1	500	33	5.2	NE	—	MBH00061	—
4	101.6	2	50.8	625	27	4.2	NE	MBH00048	MBH00062	MBH00066
4	101.6	3	76.2	500	14	2.2	NE	<b>MBH00049</b>	—	—
4	101.6	4	101.6	1250	27	4.2	NE	<b>MBH00050</b>	MBH00063	<b>MBH00067</b>
4½	114.3	1	25.4	300	23	3.5	SE	MBH00051	—	—
4½	114.3	2	50.8	700	27	4.1	NE	—	MBH00064	MBH00068
4½	114.3	4	101.6	700	13	2.1	NE	MBH00052	—	—
4½	114.3	4	101.6	1400	27	4.1	NE	<b>MBH00053</b>	<b>MBH00065</b>	MBH00069

#### Design Features:

- \* All heaters have 24" high temperature leads — **Type L2**
- \* Heaters less than 1-1/2" wide have separate straps — **Type SE**
- \* Designed as one-piece expandable type, enables you to open up the heater to the diameter of the barrel for easy installation.



#### Stock Items Are Shown In RED

ID		Width		Wattage	Watt Density		Style	Part Number		
in	mm	in	mm		W/in <sup>2</sup>	W/cm <sup>2</sup>		120V	240V	480V
3	76.2	1	25.4	200	24	3.7	SE	<b>MBH00070</b>	<b>MBH00078</b>	—
3	76.2	1	25.4	250	30	4.6	SE	<b>MBH00071</b>	<b>MBH00079</b>	—
3	76.2	1	25.4	300	36	5.5	SE	<b>MBH00072</b>	<b>MBH00080</b>	—
3	76.2	1	25.4	400	47	7.4	SE	<b>MBH00073</b>	MBH00081	—
3	76.2	1½	38.1	400	32	4.9	NE	<b>MBH00074</b>	MBH00082	—
3	76.2	1½	38.1	450	36	5.5	NE	<b>MBH00075</b>	<b>MBH00083</b>	—
3	76.2	1½	38.1	500	40	6.1	NE	<b>MBH00076</b>	<b>MBH00084</b>	—
3	76.2	2	50.8	500	30	4.6	NE	<b>MBH00077</b>	<b>MBH00085</b>	—
3½	88.9	1	25.4	400	40	6.2	SE	—	MBH00086	—
3½	88.9	1½	38.1	250	17	2.6	NE	—	MBH00087	<b>MBH00093</b>
3½	88.9	2	50.8	650	33	5.0	NE	—	MBH00088	—
4½ <sub>16</sub>	125.4	2½	63.5	720	20	3.1	NE	—	<b>MBH00089</b>	<b>MBH00094</b>
5½	139.7	2½	63.5	950	23	3.6	NE	—	MBH00090	<b>MBH00095</b>
5½	149.2	1½	38.1	675	26	4.0	NE	—	<b>MBH00091</b>	<b>MBH00096</b>
7½	190.5	1½	38.1	1000	30	4.6	NE	—	<b>MBH00092</b>	<b>MBH00097</b>



## Duraband Barrel Band Heaters

### Stock and Standard (Non-Stock) Mica Insulated Band Heaters for Plastic Injection Molding Machines



#### Design Features:

- \* All heaters have 24" high temperature leads with 22" stainless steel overbraid — **Type W1**
- \* Heaters less than 1-1/2" wide have separate straps — **Type SE**
- \* Designed as one-piece expandable type, enables you to open up the heater to the diameter of the barrel for easy installation.

#### Stock Items Are Shown In **RED**

ID		Width		Wattage	Watt Density		Style	Part Number	
in	mm	in	mm		W/in <sup>2</sup>	W/cm <sup>2</sup>		120V	240V
2½	63.5	1½	38.1	300	29	4.5	NE	MBH00098	—
3	76.2	1	25.4	300	36	5.6	SE	<b>MBH00099</b>	<b>MBH00108</b>
3	76.2	1½	38.1	500	40	6.2	NE	<b>MBH00100</b>	<b>MBH00109</b>
3	76.2	2	50.8	500	30	4.6	NE	<b>MBH00101</b>	<b>MBH00110</b>
3¾	79.4	2	50.8	450	26	4.0	NE	—	<b>MBH00111</b>
3¾	82.6	2	50.8	400	22	3.4	NE	—	<b>MBH00112</b>
3¾	88.9	1½	38.1	550	37	5.7	NE	—	<b>MBH00113</b>
3½	88.9	2	50.8	600	30	4.7	NE	—	<b>MBH00114</b>
3½	88.9	3	76.2	300	10	1.6	NE	—	<b>MBH00115</b>
3½	88.9	3	76.2	625	21	3.2	NE	—	<b>MBH00116</b>
3¾	95.3	1½	38.1	600	37	5.8	NE	MBH00102	<b>MBH00117</b>
3¾	95.3	2½	63.5	850	32	4.9	NE	MBH00103	<b>MBH00118</b>
4	101.6	1	25.4	550	48	7.4	SE	—	MBH00119
4	101.6	1½	38.1	550	32	4.9	NE	—	<b>MBH00120</b>
4¾	104.8	1	25.4	400	33	5.2	SE	<b>MBH00104</b>	—
4½	114.3	1	25.4	550	42	6.5	SE	—	<b>MBH00121</b>
4½	114.3	2	50.8	800	30	4.7	NE	—	<b>MBH00122</b>
4¾	120.7	¾	19.1	150	14	2.2	SE	—	MBH00123
4¾	123.8	1½	38.1	900	42	6.5	NE	—	MBH00124
5	127.0	1½	38.1	700	32	4.9	NE	—	<b>MBH00125</b>
5	127.0	1¾	44.5	600	23	3.6	NE	—	<b>MBH00126</b>
5	127.0	2	50.8	950	32	5.0	NE	—	MBH00127
5	127.0	2½	63.5	1000	27	4.2	NE	—	MBH00128
5½	139.7	1	25.4	550	34	5.2	SE	—	<b>MBH00129</b>
5½	139.7	1½	38.1	500	20	3.2	NE	—	MBH00130
5½	139.7	1½	38.1	900	37	5.7	NE	—	MBH00131
5½	139.7	2	50.8	500	15	2.4	NE	—	MBH00132
5½	139.7	2¾	69.9	620	14	2.1	NE	—	<b>MBH00133</b>
5½	139.7	3	76.2	1750	36	5.6	NE	—	<b>MBH00134</b>
6	152.4	1	25.4	300	17	2.6	SE	MBH00105	—
6	152.4	1½	38.1	500	19	2.9	NE	—	<b>MBH00135</b>
6	152.4	1½	38.1	850	32	4.9	NE	—	<b>MBH00136</b>
6¾	155.6	1	25.4	600	33	5.1	SE	<b>MBH00106</b>	—
6¾	158.8	2	50.8	500	13	2.1	NE	—	<b>MBH00137</b>
6¾	165.1	1½	38.1	750	26	4.0	NE	—	MBH00138
7	177.8	1	25.4	550	26	4.1	SE	—	<b>MBH00139</b>
7½	190.5	2	50.8	1500	36	5.6	NE	—	MBH00140
8¾	206.4	2	50.8	1200	38	5.9	NE	MBH00107	—
10	254.0	2	50.8	2000	41	6.4	NE	—	<b>MBH00141</b>

### Ordering Information

See page 1-48

### Stock and Standard (Non-Stock) Mica Insulated Band Heaters for Plastic Injection Molding Machines

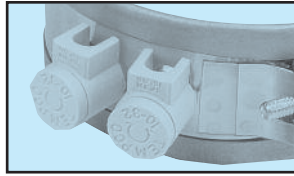

Optional Igloo™ ceramic covers can fully insulate any standard #8 or #10 terminal lugs used for electrical hook-ups. See page 1-33.

#### Design Features:

- \* Features unbreakable 10-32 screw terminals.
- \* Larger heaters (dia. 2-1/2" or greater) are designed as one-piece expandable type, enabling you to open up the heater to the diameter of the barrel for easy installation.
- \* Heaters less than 1-1/2" wide have separate straps — **Type SE**

#### Stock Items Are Shown In **RED**

ID		Width		Wattage	Watt Density		Style	Term.	Part Number		
in	mm	in	mm		W/in <sup>2</sup>	W/cm <sup>2</sup>			120V	240V	480V
1½	38.1	1	25.4	150	40	6.3	SB	T2	—	<b>MBH00170</b>	—
1½	38.1	1½	38.1	250	45	7.0	NB	T2	—	<b>MBH00171</b>	—
1½	38.1	2	50.8	300	40	6.3	NB	T2	—	<b>MBH00172</b>	—
1¾	44.5	1	25.4	175	39	6.0	SB	T2	—	<b>MBH00173</b>	—
1¾	44.5	1½	38.1	250	37	5.7	NB	T2	—	<b>MBH00174</b>	—
1¾	44.5	1½	38.1	300	44	6.9	NB	T2	—	<b>MBH00175</b>	—
1⅞	47.6	1	25.4	200	41	6.3	SB	T2	—	MBH00176	—
2	50.8	1½	38.1	300	38	5.9	NB	T2	<b>MBH00142</b>	MBH00177	—
2¼	57.2	1	25.4	250	41	6.4	SB	T2	<b>MBH00143</b>	MBH00178	—
2¼	57.2	2	50.8	525	43	6.7	NB	T2	—	MBH00179	—
2½	60.3	1	25.4	100	15	2.4	SB	T2	—	<b>MBH00180</b>	—
2½	60.3	1	25.4	250	39	6.0	SB	T2	—	MBH00181	—
2½	60.3	2½	63.5	450	28	4.3	NB	T3	<b>MBH00144</b>	—	—
2½	63.5	1	25.4	225	33	5.1	SE	T2	—	<b>MBH00182</b>	—
2½	63.5	1	25.4	250	36	5.7	SE	T2	—	<b>MBH00183</b>	—
2½	63.5	1	25.4	275	40	6.2	SE	T2	—	<b>MBH00184</b>	—
2½	63.5	1½	38.1	300	29	4.5	NE	T2	<b>MBH00145</b>	<b>MBH00185</b>	—
2½	63.5	1½	38.1	350	34	5.3	NE	T2	<b>MBH00146</b>	<b>MBH00186</b>	—
2½	63.5	2½	60.3	550	34	5.2	NE	T2	—	<b>MBH00187</b>	—
2½	63.5	2½	73.0	650	33	5.1	NE	T3	—	<b>MBH00188</b>	—
2½	63.5	4	101.6	850	31	4.8	NE	T3	—	<b>MBH00189</b>	—
3	76.2	1	25.4	200	24	3.7	SE	T2	<b>MBH00147</b>	<b>MBH00190</b>	—
3	76.2	1	25.4	250	30	4.6	SE	T2	<b>MBH00148</b>	MBH00191	—
3	76.2	1	25.4	300	36	5.5	SE	T2	—	MBH00192	—
3	76.2	1	25.4	350	42	6.4	SE	T2	—	<b>MBH00193</b>	—
3	76.2	1	25.4	400	47	7.4	SE	T2	<b>MBH00149</b>	MBH00194	<b>MBH00348</b>
3	76.2	1½	38.1	400	32	4.9	NE	T2	<b>MBH00150</b>	<b>MBH00195</b>	—
3	76.2	1½	38.1	450	36	5.5	NE	T2	—	<b>MBH00196</b>	—
3	76.2	1½	38.1	500	40	6.1	NE	T2	MBH00151	<b>MBH00197</b>	—
3	76.2	2	50.8	450	27	4.1	NE	T2	—	<b>MBH00198</b>	—
3	76.2	2	50.8	500	30	4.6	NE	T2	—	MBH00199	—
3	76.2	2½	63.5	650	31	4.8	NE	T3	—	MBH00200	—
3⅞	79.4	1	25.4	300	34	5.3	SE	T2	—	<b>MBH00201</b>	—
3⅞	79.4	1	25.4	400	45	7.0	SE	T2	<b>MBH00152</b>	<b>MBH00202</b>	—
3⅞	79.4	1½	38.1	400	30	4.7	NE	T2	—	<b>MBH00203</b>	—
3¾	82.6	1½	38.1	400	29	4.5	NE	T2	<b>MBH00153</b>	<b>MBH00204</b>	—
3½	88.9	1	25.4	300	30	4.7	SE	T2	<b>MBH00154</b>	<b>MBH00205</b>	—
3½	88.9	1½	38.1	325	22	3.4	NE	T2	—	MBH00206	—
3½	88.9	1½	38.1	400	27	4.1	NE	T2	<b>MBH00155</b>	—	—
3½	88.9	1½	38.1	500	33	5.2	NE	T2	MBH00156	<b>MBH00207</b>	—
3½	88.9	2	50.8	325	16	2.5	NE	T2	—	<b>MBH00208</b>	—
3½	88.9	2	50.8	500	25	3.9	NE	T2	<b>MBH00157</b>	—	—
3½	88.9	2	50.8	650	33	5.0	NE	T2	—	<b>MBH00209</b>	—
3½	88.9	2½	63.5	750	30	4.7	NE	T3	—	<b>MBH00210</b>	—
3½	88.9	3	76.2	1000	33	5.2	NE	T3	—	MBH00211	—
3⅞	90.5	2⅞	60.3	685	28	4.4	NE	T2	—	<b>MBH00212</b>	—
3⅞	92.2	1½	38.1	625	40	6.2	NE	T2	—	MBH00213	—
3¾	95.3	1	25.4	350	32	5.0	SE	T2	<b>MBH00158</b>	<b>MBH00214</b>	—
3¾	95.3	1½	38.1	500	31	4.8	NE	T2	—	MBH00215	—
3¾	95.3	1½	38.1	700	43	6.7	NE	T2	—	<b>MBH00216</b>	—
3¾	95.3	2½	63.5	850	32	4.9	NE	T3	MBH00159	<b>MBH00217</b>	—
3⅞	98.4	1½	38.1	550	33	5.1	NE	T2	—	<b>MBH00218</b>	—

**CONTINUED** 

# Band Heaters



## Duraband Barrel Band Heaters

### Stock and Standard (Non-Stock) Mica Insulated Band Heaters for Plastic Injection Molding Machines

Continued from previous page...

ID		Width		Wattage	Watt Density		Style	Term.	Part Number		
in	mm	in	mm		W/in <sup>2</sup>	W/cm <sup>2</sup>			120V	240V	480V
3 <sup>3</sup> / <sub>8</sub>	98.4	2	50.8	750	34	5.2	NE	T2	—	<b>MBH00219</b>	—
3 <sup>1</sup> / <sub>2</sub>	100.0	2	50.8	600	26	4.1	NE	T2	—	<b>MBH00220</b>	—
4	101.6	1	25.4	400	35	5.4	SE	T2	<b>MBH00160</b>	MBH00221	—
4	101.6	1 <sup>1</sup> / <sub>2</sub>	38.1	400	23	3.6	NE	T2	—	MBH00222	—
4	101.6	1 <sup>1</sup> / <sub>2</sub>	38.1	550	32	4.9	NE	T2	—	<b>MBH00223</b>	—
4	101.6	1 <sup>1</sup> / <sub>2</sub>	38.1	625	36	5.6	NE	T2	—	<b>MBH00224</b>	MBH00349
4	101.6	1 <sup>1</sup> / <sub>2</sub>	38.1	750	43	6.7	NE	T2	—	MBH00225	—
4	101.6	2	50.8	550	24	3.7	NE	T2	<b>MBH00161</b>	<b>MBH00226</b>	—
4	101.6	2	50.8	800	35	5.4	NE	T2	—	<b>MBH00227</b>	—
4	101.6	2 <sup>1</sup> / <sub>4</sub>	57.2	900	35	5.4	NE	T2	—	MBH00228	—
4	101.6	2 <sup>1</sup> / <sub>2</sub>	63.5	1000	35	5.4	NE	T3	—	<b>MBH00229</b>	—
4	101.6	4	101.6	1250	27	4.2	NE	T3	—	<b>MBH00230</b>	—
4 <sup>1</sup> / <sub>2</sub>	109.5	3 <sup>1</sup> / <sub>2</sub>	88.9	1210	28	4.3	NE	T3	—	MBH00231	—
4 <sup>1</sup> / <sub>2</sub>	114.3	1	25.4	350	27	4.1	SE	T2	<b>MBH00162</b>	MBH00232	—
4 <sup>1</sup> / <sub>2</sub>	114.3	1 <sup>1</sup> / <sub>2</sub>	38.1	350	18	2.8	NE	T2	—	<b>MBH00233</b>	—
4 <sup>1</sup> / <sub>2</sub>	114.3	1 <sup>1</sup> / <sub>2</sub>	38.1	400	20	3.1	NE	T2	—	MBH00235	—
4 <sup>1</sup> / <sub>2</sub>	114.3	1 <sup>1</sup> / <sub>2</sub>	38.1	650	33	5.1	NE	T2	—	<b>MBH00236</b>	—
4 <sup>1</sup> / <sub>2</sub>	114.3	2	50.8	500	19	2.9	NE	T2	MBH00163	<b>MBH00237</b>	—
4 <sup>1</sup> / <sub>2</sub>	114.3	2	50.8	700	27	4.1	NE	T2	MBH00164	MBH00238	—
4 <sup>1</sup> / <sub>2</sub>	114.3	2 <sup>1</sup> / <sub>2</sub>	63.5	1000	30	4.7	NE	T3	<b>MBH00165</b>	MBH00239	—
4 <sup>3</sup> / <sub>4</sub>	120.7	1 <sup>1</sup> / <sub>2</sub>	38.1	600	29	4.5	NE	T2	—	MBH00242	<b>MBH00350</b>
4 <sup>3</sup> / <sub>4</sub>	120.7	1 <sup>1</sup> / <sub>2</sub>	38.1	650	31	4.8	NE	T2	—	<b>MBH00243</b>	—
4 <sup>3</sup> / <sub>4</sub>	120.7	3	76.2	1100	26	4.1	NE	T3	—	<b>MBH00244</b>	<b>MBH00351</b>
4 <sup>7</sup> / <sub>8</sub>	123.8	1 <sup>1</sup> / <sub>2</sub>	38.1	900	42	6.5	NE	T2	—	<b>MBH00245</b>	—
4 <sup>7</sup> / <sub>8</sub>	123.8	2	50.8	650	23	3.5	NE	T2	—	<b>MBH00246</b>	—
4 <sup>7</sup> / <sub>8</sub>	123.8	2	50.8	760	27	4.1	NE	T2	—	<b>MBH00247</b>	MBH00352
4 <sup>7</sup> / <sub>8</sub>	123.8	3	76.2	900	21	3.2	NE	T3	—	<b>MBH00248</b>	—
4 <sup>1</sup> / <sub>2</sub>	125.4	3	76.2	1200	28	4.3	NE	T3	—	<b>MBH00249</b>	—
5	127.0	1	25.4	400	27	4.2	SE	T2	—	<b>MBH00250</b>	—
5	127.0	1 <sup>1</sup> / <sub>2</sub>	38.1	350	16	2.5	NE	T2	—	—	MBH00353
5	127.0	1 <sup>1</sup> / <sub>2</sub>	38.1	700	32	4.9	NE	T2	—	MBH00251	—
5	127.0	1 <sup>1</sup> / <sub>2</sub>	38.1	800	36	5.6	NE	T2	—	MBH00252	—
5	127.0	2	50.8	1000	34	5.3	NE	T2	—	<b>MBH00253</b>	—
5	127.0	2 <sup>1</sup> / <sub>2</sub>	63.5	1000	27	4.2	NE	T3	—	<b>MBH00254</b>	—
5	127.0	3	76.2	1200	27	4.2	NE	T3	—	MBH00255	<b>MBH00354</b>
5	127.0	3 <sup>1</sup> / <sub>4</sub>	82.6	800	17	2.6	NE	T3	—	—	MBH00355
5	127.0	3 <sup>1</sup> / <sub>4</sub>	82.6	1250	26	4.1	NE	T3	—	MBH00256	—
5	127.0	4	101.6	1500	25	4.0	NE	T3	—	<b>MBH00257</b>	—
5 <sup>1</sup> / <sub>8</sub>	130.2	1 <sup>1</sup> / <sub>2</sub>	38.1	900	40	6.2	NE	T2	—	MBH00258	—
5 <sup>1</sup> / <sub>8</sub>	130.3	1 <sup>1</sup> / <sub>2</sub>	38.1	600	26	4.1	NE	T2	—	<b>MBH00259</b>	—
5 <sup>1</sup> / <sub>4</sub>	133.4	1	25.4	500	32	5.0	SE	T2	—	MBH00260	—
5 <sup>1</sup> / <sub>4</sub>	133.4	1	25.4	600	39	6.0	SE	T2	—	<b>MBH00261</b>	<b>MBH00356</b>
5 <sup>1</sup> / <sub>4</sub>	133.4	1 <sup>1</sup> / <sub>2</sub>	38.1	600	26	4.0	NE	T2	—	MBH00262	<b>MBH00357</b>
5 <sup>1</sup> / <sub>4</sub>	133.4	1 <sup>1</sup> / <sub>2</sub>	38.1	1000	43	6.7	NE	T2	—	MBH00263	—
5 <sup>1</sup> / <sub>4</sub>	133.4	2	50.8	1000	32	5.0	NE	T2	—	<b>MBH00264</b>	—
5 <sup>1</sup> / <sub>4</sub>	133.4	2 <sup>1</sup> / <sub>4</sub>	57.2	1300	37	5.8	NE	T2	—	—	MBH00358
5 <sup>1</sup> / <sub>4</sub>	133.4	2 <sup>1</sup> / <sub>2</sub>	63.5	1300	34	5.2	NE	T3	—	<b>MBH00265</b>	—
5 <sup>1</sup> / <sub>4</sub>	133.4	3	76.2	1700	37	5.7	NE	T3	—	<b>MBH00266</b>	—
5 <sup>1</sup> / <sub>2</sub>	139.7	1 <sup>1</sup> / <sub>2</sub>	38.1	800	33	5.1	NE	T2	—	MBH00267	—
5 <sup>1</sup> / <sub>4</sub>	146.1	1 <sup>1</sup> / <sub>2</sub>	38.1	600	23	3.6	NE	T2	—	<b>MBH00268</b>	—
5 <sup>7</sup> / <sub>8</sub>	149.2	3	76.2	1000	19	3.0	NE	T3	—	<b>MBH00269</b>	—
5 <sup>1</sup> / <sub>2</sub>	150.8	1 <sup>1</sup> / <sub>2</sub>	38.1	1000	38	5.9	NE	T2	—	<b>MBH00270</b>	—
6	152.4	1	25.4	500	28	4.3	SE	T2	—	<b>MBH00271</b>	—
6	152.4	1 <sup>1</sup> / <sub>8</sub>	34.9	950	39	6.0	SE	T2	MBH00166	—	—
6	152.4	1 <sup>1</sup> / <sub>2</sub>	38.1	600	22	3.5	NE	T2	—	MBH00272	—
6	152.4	1 <sup>1</sup> / <sub>2</sub>	38.1	850	32	4.9	NE	T2	<b>MBH00167</b>	<b>MBH00273</b>	—
6	152.4	1 <sup>1</sup> / <sub>2</sub>	38.1	900	34	5.2	NE	T2	—	<b>MBH00274</b>	—
6	152.4	1 <sup>1</sup> / <sub>2</sub>	38.1	1000	40	6.2	NE	T2	—	<b>MBH00275</b>	—
6	152.4	2	50.8	1200	34	5.2	NE	T2	—	MBH00276	—
6	152.4	2 <sup>1</sup> / <sub>2</sub>	63.5	1450	32	5.0	NE	T3	—	<b>MBH00277</b>	—
6	152.4	3	76.2	1400	26	4.1	NE	T3	—	MBH00278	<b>MBH00359</b>
6 <sup>1</sup> / <sub>8</sub>	155.6	1 <sup>1</sup> / <sub>2</sub>	38.1	1000	37	5.7	NE	T2	—	MBH00279	—
6 <sup>1</sup> / <sub>4</sub>	158.8	3	76.2	1500	27	4.2	NE	T3	—	<b>MBH00280</b>	MBH00360
6 <sup>1</sup> / <sub>2</sub>	160.3	3	76.2	1250	22	3.4	NE	T3	—	<b>MBH00281</b>	MBH00361
6 <sup>1</sup> / <sub>2</sub>	164.3	2	50.8	800	21	3.2	NE	T2	—	<b>MBH00282</b>	—
6 <sup>1</sup> / <sub>2</sub>	164.3	2	50.8	1200	33	5.1	NE	T2	—	<b>MBH00283</b>	—

Stock Items Are  
Shown In **RED**

**Order  
Info.**  
See page 1-48

### Stock and Standard (Non-Stock) Mica Insulated Band Heaters for Plastic Injection Molding Machines

ID		Width		Wattage	Watt Density		Style	Term.	120V	Part Number		
in	mm	in	mm		W/in <sup>2</sup>	W/cm <sup>2</sup>				240V	480V	
6½	165.1	1½	38.1	750	26	4.0	NE	T2	—	MBH00284	—	
6½	165.1	1½	38.1	900	31	4.8	NE	T2	—	MBH00285	—	
6½	165.1	1½	38.1	1200	41	6.4	NE	T2	—	MBH00286	—	
6½	165.1	2	50.8	1000	26	4.0	NE	T2	—	<b>MBH00287</b>	—	
6½	165.1	2½	63.5	1200	25	3.8	NE	T3	—	MBH00288	<b>MBH00362</b>	
6⅝	168.4	1½	38.1	815	27	4.2	NE	T2	—	<b>MBH00289</b>	—	
6⅝	168.4	1½	38.1	1150	39	6.0	NE	T2	—	MBH00290	—	
6¾	171.5	1½	38.1	600	20	3.1	NE	T2	—	<b>MBH00291</b>	—	
6¾	171.5	1½	38.1	815	27	4.2	NE	T2	—	<b>MBH00292</b>	—	
6¾	171.5	1½	38.1	1000	33	5.1	NE	T2	—	MBH00293	—	
6¾	171.5	1½	38.1	1150	38	5.9	NE	T2	—	MBH00294	—	
6¾	171.5	2	50.8	1300	32	5.0	NE	T2	—	MBH00295	—	
6¾	171.5	4	101.6	2600	32	5.0	NE	T3	—	<b>MBH00296</b>	—	
7	177.8	1	25.4	750	36	5.5	SE	T2	—	<b>MBH00297</b>	—	
7	177.8	1½	38.1	950	30	4.7	NE	T2	—	MBH00298	—	
7	177.8	1½	38.1	1000	32	4.9	NE	T2	—	<b>MBH00299</b>	—	
7	177.8	2½	63.5	1000	19	3.0	NE	T3	—	MBH00300	—	
7	177.8	3	76.2	1650	26	4.1	NE	T3	—	MBH00301	<b>MBH00363</b>	
7½	180.2	3½	88.9	1200	16	2.5	NE	T3	—	<b>MBH00302</b>	<b>MBH00364</b>	
7½	180.2	3½	88.9	1650	22	3.4	NE	T3	—	<b>MBH00303</b>	<b>MBH00365</b>	
7⅝	181.0	1½	38.1	1200	37	5.8	NE	T2	—	<b>MBH00304</b>	—	
7⅝	181.0	3½	88.9	1650	22	3.4	NE	T3	—	<b>MBH00305</b>	—	
7¾	184.2	2	50.8	900	21	3.2	NE	T2	—	<b>MBH00306</b>	—	
7½	190.5	1	25.4	700	31	4.8	SE	T2	MBH00168	—	—	
7½	190.5	1½	38.1	800	24	3.7	NE	T2	—	<b>MBH00307</b>	—	
7½	190.5	1½	38.1	1000	30	4.6	NE	T2	—	<b>MBH00308</b>	—	
7½	190.5	2	50.8	1500	36	5.2	NE	T2	—	<b>MBH00309</b>	—	
7½	190.5	3	76.2	1800	27	4.1	NE	T2	—	<b>MBH00310</b>	<b>MBH00366</b>	
7⅞	193.7	1½	38.1	1000	29	4.5	NE	T2	—	<b>MBH00311</b>	—	
7⅞	193.7	3	76.2	2000	29	4.5	NE	T2	—	MBH00312	—	
7¾	196.9	1½	38.1	1000	29	4.4	NE	T2	—	<b>MBH00313</b>	—	
7¾	200.0	1½	38.1	750	21	3.3	NE	T2	—	MBH00314	—	
7¾	200.0	1½	38.1	1000	28	4.4	NE	T2	—	<b>MBH00315</b>	—	
7¾	200.0	3	76.2	2000	28	4.4	NE	T3	—	<b>MBH00316</b>	—	
8	203.2	1	25.4	850	35	5.5	SE	T2	—	<b>MBH00317</b>	—	
8	203.2	1½	38.1	950	26	4.1	NE	T2	—	MBH00318	—	
8	203.2	1½	38.1	1200	33	5.1	NE	T2	—	<b>MBH00319</b>	MBH00367	
8	203.2	1½	38.1	1400	39	6.0	NE	T2	—	MBH00320	—	
8	203.2	2	50.8	1500	31	4.8	NE	T2	—	<b>MBH00321</b>	<b>MBH00368</b>	
8	203.2	3	76.2	2250	31	4.8	NE	T3	—	<b>MBH00322</b>	<b>MBH00369</b>	
8¼	209.6	2	50.8	1800	36	5.6	NE	T2	—	MBH00323	<b>MBH00370</b>	
8¼	209.6	4	101.6	3000	30	4.7	NE	T3	—	MBH00324	<b>MBH00371</b>	
8½	215.9	1½	38.1	1200	31	4.8	NE	T2	—	<b>MBH00325</b>	—	
8½	215.9	2	50.8	1600	31	4.8	NE	T2	—	<b>MBH00326</b>	—	
8¾	222.3	3	76.2	2000	25	3.9	NE	T3	—	<b>MBH00327</b>	MBH00372	
9	228.6	1½	38.1	1300	32	4.9	NE	T2	—	MBH00328	—	
9	228.6	1½	38.1	1500	37	5.7	NE	T2	—	MBH00329	MBH00373	
9	228.6	2	50.8	1800	33	5.1	NE	T2	—	<b>MBH00330</b>	—	
9½	241.3	1½	38.1	1600	40	5.7	NE	T2	—	<b>MBH00331</b>	—	
9½	241.3	2	50.8	1800	31	4.8	NE	T2	—	MBH00332	—	
9½	241.3	3	76.2	2000	23	3.6	NE	T3	—	<b>MBH00333</b>	<b>MBH00374</b>	
9¾	244.5	3	76.2	2000	23	3.5	NE	T3	—	MBH00334	<b>MBH00375</b>	
9¾	244.5	3	76.2	3000	34	5.3	NE	T3	—	MBH00335	<b>MBH00376</b>	
9¾	247.7	2	50.8	2000	34	5.2	NE	T2	—	<b>MBH00336</b>	—	
10	254.0	1½	38.1	1400	31	4.8	NE	T2	—	<b>MBH00337</b>	—	
10¼	260.4	3	76.2	2400	26	4.0	NE	T3	—	<b>MBH00338</b>	MBH00377	
10¼	260.4	4	101.6	3000	24	3.7	NE	T3	—	<b>MBH00339</b>	<b>MBH00378</b>	
10½	266.7	1½	38.1	1500	31	4.8	NE	T2	—	MBH00340	—	
10½	266.7	3	76.2	2400	25	3.9	NE	T3	—	MBH00341	<b>MBH00379</b>	
11	279.4	1½	38.1	1600	32	4.9	NE	T2	—	MBH00342	—	
11	279.4	2	50.8	2000	30	4.6	NE	T2	—	<b>MBH00343</b>	—	
11¼	285.8	3	76.2	2400	23	3.6	NE	T3	—	MBH00344	—	
11½	292.1	1½	38.1	800	15	2.4	NE	T2	<b>MBH00169</b>	—	—	
11½	292.1	1½	38.1	1800	34	5.3	NE	T2	—	<b>MBH00345</b>	—	
12	304.8	1½	38.1	2000	36	5.6	NE	T2	—	<b>MBH00346</b>	—	
12	304.8	2	50.8	2300	31	4.9	NE	T2	—	MBH00347	MBH00380	

Stock Items Are  
Shown In **RED**

**Order Info.**  
See page 1-48