

Tubular Heaters



Finned Tubular Heaters

Finned Tubular Heaters

Shown with optional bulkhead fittings



Shown with optional mounting flange at end of sheath

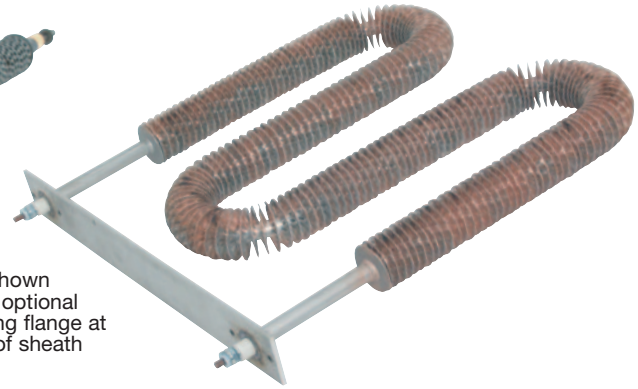

Design Features

- * Copper brazed steel fins on steel sheath standard. Aluminum based protective coating available.
- * Stainless steel fins on stainless alloy sheath standard.
- * .315, .430, & .475 Sheath diameters standard. .260 & .375 diameters optional. .625 diameter is special order in limited lengths.
- * 5/16" fins standard on .315 diameter units, 3/8" fins on .430 & .475 diameter heaters. See physical specifications for optional sizes.
- * Monel fins on Monel sheath available on special order only. Consult Tempco for details.
- * 4.5-5 fins/in standard. 3.5-6 fins/in optional
- * Steel finned catalog heaters have brazed brass bulkheads. Welded steel or staked bulkheads available. Stainless steel welded bulkheads are standard on cataloged stainless steel finned heaters. Fittings will have UNF threads unless custom threads are specified. See page 10-16B.
- * Custom Mounting Brackets can be provided. See page 10-16C.

Construction Characteristics

THF finned heaters are constructed using Tempco's robust tubular element as the basis of construction. Fin material is continuously spiral wound tightly onto the element surface to increase the convective surface area for air and non-corrosive gas heating. Fin spacing and size have been tested and selected to optimize performance. Steel finned units are then furnace brazed, bonding the fins to the sheath to increase conductive efficiency. This allows higher wattage levels to be achieved in the same flow area and produces lower sheath temperatures prolonging heater life. For higher temperature or more corrosive applications, stainless steel fins securely wound on alloy sheath are available. Application conditions such as vibration and toxic/flammable media should be taken into consideration when installing heaters. Protective coatings are available for use on steel finned heaters for mildly corrosive or high humidity applications.

Finned tubular elements are safer to operate than open coil heaters as the risk of fire from combustible particles in the flow stream and electrical shock is minimized. Increased service life and less maintenance required due to the rugged finned element construction. Power loading (w/in) of finned tubulars can be matched to any open coil installation. Pressure drop when using finned elements will be slightly more than with open coil but normally not enough to matter. It varies with flow velocity ranging from .04"H₂O at 500 fpm to about .30"H₂O at 1500 fpm when elements are banked together in several rows for duct heaters.

- * Type T Post terminals standard. .315 dia. heaters have 8-32 threads and 10-32 threads are used on .430 & .475 dia. heaters. Full selection of tubular terminations available See page 10-4.
- * Catalog units have V2A silicon resin seals as standard. Most all other tubular seal options available. See page 10-16C.
- * Numerous factory bending formations available. Supply Tempco with dimensional sketch, drawing, or photo. See page 10-9.
- * Bright annealed, Nickel plating, Hi-heat aluminum, or Hi-heat flat black finishes available Furnace brazed Stainless Steel fins available as an option.
- * U2 & M2 formations are ideal for duct heating applications
- * Unfinned sections in bends or straight lengths of heated area can be provided on heaters up to 32wsi sheath watt density.
- * Catalog listed Steel heaters are UL recognized for use up to 750°F sheath temperature & Stainless construction up to 1000°F at a maximum of 85 wsi on sheath.

The finned tubular elements are normally used in forced or free convective air applications at low to medium temperatures. Typical applications are for heating indoor clean air from ambient conditions up to 250/275°F for steel finned units & 550°F for stainless fins. Steel finned heaters can be operated up to 750°F on sheath and stainless steel finned heaters used up to 1200°F (1000°F UL limit) sheath temperatures. Nominal sheath watt density and recommended operating conditions for the cataloged heaters are included in the table headings & footnotes. Lower airflows will require lower watt density ratings. Consideration should be given to using un-finned alloy sheath tubular elements for heating to higher outlet air temperatures or if operating in higher ambient air. Application conditions of flow velocity and inlet/outlet temperatures will govern sheath watt density to be used. The airflow graphs and examples presented will help with determining proper heater watt density. The cataloged designs are suitable for most low temperature applications that will be encountered.



Finned Tubular Heaters are UL recognized and CSA certified up to 85W/in² and 750°F for Steel sheath/steel finned and .85W/in² and 1000°F for Alloy or SS sheath/SS finned. The UL File Number is E65652 (CCN KSOT2/KSOT8).

If you require UL, CSA, or other NRTL agency approvals, please specify when ordering.

Typical Applications

- Convective air & gas heating in ducts
- Load resistor banks
- Moisture removal (dehumidification)
- Curing ovens & plastics dryers
- Low/medium temperature heat treating
- Convection ovens for food preparation
- Exhaust gas heating
- Forced air electric heaters
- Heat pump auxiliary systems
- Return air heating
- Inert Industrial process gas heating
- Organic Resins & Paint curing, baking & drying
- Autoclaves
- Film & ink drying
- Hopper heating
- Chemical processing & core drying
- Food Roasting & baking
- Textile & Varnish drying
- Heating for rail & marine applications

TUBULAR ELEMENT SIZES & MATERIALS

Sheath Diameter: .315", .375", .430" and .475"

Sheath Material: Steel, 304L SS, 316L SS, Incoloy 840 and Incoloy 800

Sheath Lengths: 12" to 196" depending on sheath diameter

Sheath Material Selection

Standard steel finned heaters are ideal for use in low temperature clean air applications not containing toxic contaminants or high humidity. When coated with one of the optional coatings available they are suitable for high humidity, organic vapors, or mildly corrosive applications. Stainless steel finned heaters should be employed for higher temperature uses or if the air/gas contains vapors known to be corrosive to steel. Optional nickel plated heaters can also be provided.

PERFORMANCE RATINGS

Maximum Temperature:

Steel fins on steel sheath—750°F (400°C)

Steel fins on Incoloy or SS sheath—750°F (400°C)

Stainless Steel fins on stainless, Incoloy 840 or Incoloy 800 sheath—1200°F (650°C)

Maximum Element Power Density Limits:

.315 dia.—84 watts/linear inch

.375 dia.—100 watts/linear inch

.430 dia.—115 watts/linear inch

.475 dia.—127 watts/linear inch

These values are for heaters with 3/8" fins at 4.5-5 fins/inch. De-rate to 83% for heaters with 5/16" fins or that have less than 4.5 fins/inch.

ELECTRICAL RATINGS

Maximum Voltage: Up to 600VAC (480V for UL)

Resistance Tolerance: +10%, -5%

Wattage Tolerance: +5%, -10%

Sheath watt density range: 20-85 wsi (2-13 w/cm²), @ 4.5-5 fins/in

OPTIONAL FEATURES

Bulkhead Fittings: Brazed brass are standard. Welded or brazed Steel & SS optional. UNF threads standard, metric or special threads available.

Custom mounting brackets: (type MF or special). Dimensional sketch or drawing needed with material specs.

Locator washer: (type LC) specify location

Adjustable mounting collar: (type MC) w/set screw

Full selection of tubular termination options: Bulkhead fittings & type T post terminals standard.

Moisture Seals: V2A Silicon resin seal standard

SPECIFICATIONS AND PHYSICAL SIZE OF FINNS

Fin Materials and Attachment Method:

Steel & 304 SS

Steel wound with copper wire between fins for oven brazing to sheath. Stainless steel is mechanically wound but can be oven brazed as an option if a bright annealing atmosphere is used.

Fin Strip Width:

5/16" on .315, .375 and .430 diameters

3/8" on .315, .375 .430 and .475 diameters

Fin Thickness:

26 Ga. (.018) for Steel and 304 SS. Optional 24 Ga. (.024) for steel only

Finned OD's:

.315" dia. with 5/16" fins— .92" OD

.315" dia. with 3/8" fins—1.05" OD

.375" dia. with 5/16" fins— .98" OD

.375" dia. with 3/8" fins—1.11" OD

.430" dia. with 5/16" fins—1.04" OD

.430" dia. with 3/8" steel fins—1.15" OD, SS fins 1.16" OD

.475" dia. with 3/8" fins—1.21" OD

Fin Pitch Standards:

5±.5 for 5/16 material, 4.5-5 for 3/8 material (up to 6 per inch maximum)

SURFACE FINISHES

Oven brazed steel finned units - standard

Copper brazed stainless steel fins using inert atmosphere - special

Bright annealed steel or stainless steel finned heaters

High heat aluminum painted steel — 700°F Maximum

High heat flat black painted surface — 1000°F Maximum

Nickel plated finish — 500°F Maximum

FORMING LIMITATIONS

Minimum Element Centerline Bend Radius:

.315" dia. with 5/16" fins 3/4"

.315" dia. with 3/8" fins 7/8"

.375" dia. with 5/16" fins 7/8"

.375" dia. with 3/8" fins 1.00"

.430" dia. with 5/16" fins 1.00"

.430" dia. with 3/8" fins 1.00"

.475" dia. with 3/8" fins 1.00"

The above values are for factory formed heaters. Consult Tempco for field bending limits.

Tubular Heaters



Finned Tubular Heaters

Fitting Attachment Method — General Guidelines

These are guidelines only. Consult Tempco if you require assistance in determining the method best suited to your application.

Fittings Crimped: Low pressure water (up to 80 psig) and non-pressure air applications

Fittings Brazed: Non-ferrous alloys (copper) and dissimilar non-weldable metals

Fittings Welded: High pressure liquids and gases, and high temperature applications

Standard Bulkhead Fittings For Tubular Heaters — Round Flanged Standard

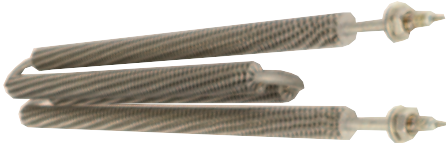
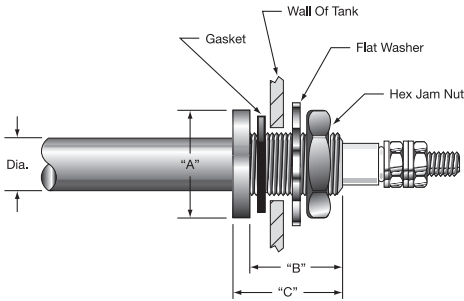

Tubular Diameter		Fitting Material	Flange Type	"A"		"B"		"C"		Thread Size (UNF)
in	mm			in	mm	in	mm	in	mm	
.315	8.0	Brass	Round	3/4	19	1/2	12.7	5/8	16	1/2-20
.315	8.0	Stn. Stl.	Round	3/4	19	1/2	12.7	5/8	16	1/2-20
.375	9.5	Brass	Round	3/4	19	1/2	12.7	5/8	16	1/2-20
.375	9.5	Stn. Stl.	Round	3/4	19	1/2	12.7	5/8	16	1/2-20
.430	10.9	Brass	Round or Hex	7/8	22	3/4	19.0	7/8	22	5/8-18
.430	10.9	Stn. Stl.	Round or Hex	7/8	22	3/4	19.0	7/8	22	5/8-18
.430	10.9	Steel	Round	7/8	22	3/4	19.0	7/8	22	5/8-18
.475	12.1	Brass	Round	7/8	22	3/4	19.0	7/8	22	5/8-18
.475	12.1	Stn. Stl.	Round	7/8	22	3/4	19.0	7/8	22	5/8-18
.475	12.1	Steel	Round	7/8	22	3/4	19.0	7/8	22	5/8-18
.475	12.1	Brass	Round	1	25	3/4	19.0	7/8	22	3/4-16
.475	12.1	Stn. Stl.	Round	1	25	3/4	19.0	7/8	22	3/4-16
.625	15.9	Stn. Stl.	Round	1-1/8	29	3/4	19.0	1	25	7/8-14



Note: Optional Larger Thread Sizes and Hex Flanged Bulkhead Fittings are available. Consult Tempco with your requirements.

Tubular Heater Standard Mounting Methods

Part Number	For Element Diameter		"A" Thick		"B" OD	
	in	mm	in	mm	in	mm
FAS-108-102	.315	8.0	5/16	7.9	5/8	15.9
FAS-108-103	.375	9.5	3/8	9.5	3/4	19.1
FAS-108-104	.430	10.9	7/16	11.1	7/8	22.2
FAS-108-106	.475	12.0	7/16	11.1	1	25.4

TYPE MC — Mounting Collar

Plated steel mounting collars are locked in place with a set-screw and serve as an adjustable stop for through-the-wall mounting. Collars are shipped in bulk unless otherwise specified. Mounting collars can be ordered with the heater or purchased separately.

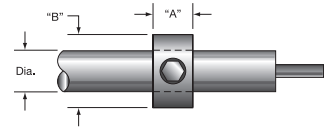

TYPE LR — Locator Washer

Locator washers are permanently attached to the heater sheath by staking/crimping and are used to limit the movement of the heater while allowing for expansion and contraction of the heater sheath. When ordering, specify location from end of sheath.

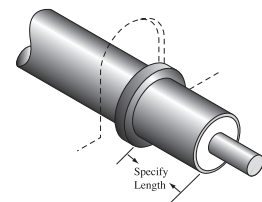

TYPE MF — Mounting Bracket

Tempco's made-to-order mounting brackets are made from 18 gauge stainless steel for strength and stiffness. It is an economical way to mount the heater in non-pressurizing, non-liquid applications. Unless otherwise specified, the bracket will be located 1/2" from the edge of the heater sheath. OEM quantity brackets are manufactured by Tempco on our own high speed precision N/C Turret Press. The standard method of attaching the tubular element to the bracket is staking or crimping.

The rectangular mounting bracket shown at right is a popular made-to-order design. Specify all dimensions shown when requesting a quote.

Custom brackets of any size, thickness or material can be supplied to meet your requirements.

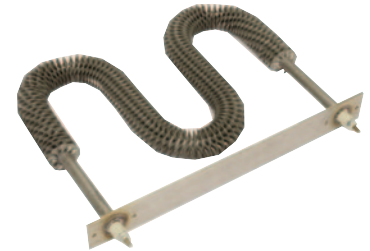
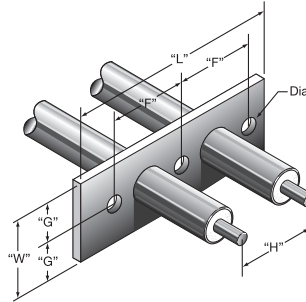

Tubular Heater Standard Moisture Seals

Magnesium Oxide (MgO) is used as the insulating material in Tempco tubular heaters because of its excellent thermal conductivity and dielectric strength. However, MgO is hygroscopic and can absorb moisture from the atmosphere. This absorption of moisture may be detected when an Insulation Resistance (IR) test is done with a megohmmeter prior to energizing the heater circuit. In very humid environments, circuits utilizing a GFI (ground fault interrupter) for safety may experience nuisance tripping when energizing the heater.

The Tempco manufacturing process produces a dry element with an IR of several thousand megohms minimum. However, after shipment and depending on humidity levels and storage time, a heater can absorb moisture and show a decrease in IR. In many cases, depending on the supply voltage and the application, the heater can be safely energized and will dry itself out.

If a heater has absorbed moisture, a safe and effective method of drying it out prior to installation is to bake it in an oven at 300°F (149°C) until an acceptable IR reading is obtained. When possible, removing the terminal hardware will expedite this process. If this method is not practical consult factory for other recommendations.

For applications where moisture absorption would be unacceptable Tempco has several optional element end seals to retard absorption of moisture in the MgO. If a true hermetic seal is required, ceramic to metal end seals (Type H) are available. With any of these seals, the maximum recommended termination temperature in the seal area must not be exceeded.

Style SS—Silicone Resin Seal

A brushed-on coating that penetrates the MgO, offering economical moisture protection under humid storage conditions.

Maximum Usable Termination Temperature: 390°F (200°C)

UL Rated Maximum Termination Temperature: 221°F (105°C)

Type V2A: conformal coating

Type V2B: silicone oil

Style SER—RTV Seal

RTV (room temperature vulcanizing) silicone rubber adhesive sealant provides a good moisture seal.

UL Rated – Maximum Termination Temperature:

Type R: 302°F (150°C)

Type R1: 392°F (200°C)

Style SEH—Epoxy Resin Seal

Epoxy resin provides a moisture resisting barrier.

UL Rated – Maximum Termination Temperature:

Type V: 194°F (90°C)

Type V1: 266°F (130°C)

Type V4: 392°F (200°C)

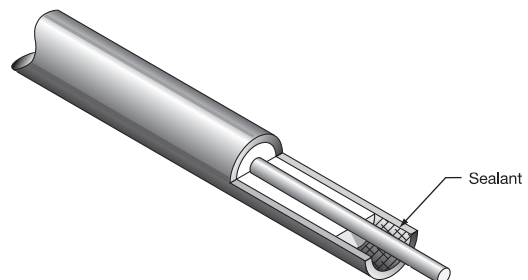

Finned Tubular Heaters

Design Guidelines

The major factors that need to be considered when specifying THF finned tubular heaters are as follows:

- Minimum FPM airflow velocity at heater inlet. Is it continuous or fluctuating
- Inlet air temperature
- Outlet air temperature and temperature rise through heating elements
- Selection of element watt density to keep sheath material within its temperature limits
- Sheath material selection
- Condition of air or gas to be heated
- Mounting & airflow restrictions around elements
- KW sizing and # of circuits required (48 amp max/circuit)
- Temperature sensors & flow controls

Heater KW Sizing

Once the inlet temperature, outlet temperature, process CFM, and operating pressure are known, the KW required for the application can be determined using the following equations. If the process is heating air & operating from ambient temperature and atmospheric pressure (70° +/- 10°F & 14.7 psi), the following formula can be used;

$$KW = \{[SCFM \times (T2-T1)] \div 3190\} + S.F.$$

Where:

T2 = °F outlet temperature

T1 = °F inlet temperature

SCFM = standard air flow in cu.ft./min. at atmospheric pressure and ambient temperature

S.F. = safety factor % to account for process losses

Converting CFM to SCFM

If the air heating process is pressurized or operating at an inlet temperature other than at or near ambient, the CFM at a point in the process with a known pressure & temperature must be used & converted to standard SCFM by the following formula;

$$SCFM = 35.4 \times CFM_2 \times \{(P_2+14.7) \div (T_2 + 460)\}$$

Where CFM₂ is cu.ft./min. air flow at process pressure P₂.

P₂ = process pressure (psig)

T₂ = inlet °F or temperature at point of measured CFM₂

Using the SCFM and the heater face flow area we can now calculate the air velocity in SFPM into the heater core as follows;

$$SFPM = SCFM \div A1$$

SFPM = inlet air velocity at standard conditions.

A1 = Sq.Ft. of inlet flow area at heater

An alternate method for calculating KW needed to heat air or other gas, from any inlet to outlet temperature can be done using the following general energy equation;

$$KW = \{[60 \text{ min/hr} \times SCFM \times \text{Density} \times \text{Sp Ht} \times \Delta T] \div 3412\} + S.F.$$

Where:

SCFM = standard air flow in cubic feet/min (@ 70°F & 14.7 psia)

Density = Gas density in lbs/cuft at standard conditions or if pressurized process at process pressure and inlet temperature. (see table)

Sp Ht = Specific heat of gas in Btu/lb-°F at standard conditions or if pressurized process at process pressure and inlet temperature. (values for air are shown in the gas density table)

ΔT = Process gas temperature rise -°F

3412 = conversion factor for Btu/hr to KW (1 KW = 3412 Btu/hr)

S.F. = safety factor % to account for process losses.

Using the inlet air velocity at the heater and the maximum outlet temperature desired the maximum sheath watt density can now be determined from the following charts for the type of heater being specified if a cataloged design is not suitable. The physical size and constraints of the application will dictate the final configuration and number of heaters required. For large installations, 3 phase circuits need to be balanced and all circuits limited no more than 48 amps per circuit. If voltages are higher than 250V, .375, .430, or .475 diameter elements are recommended.

Sheath Watt Density

The maximum sheath watt density to be specified is directly determined by the operating variables of FPM airflow velocity and inlet/outlet air/gas temperatures required. It must be selected such that sheath operating temperatures are not exceeded; 750°F for steel sheath-steel finned, or 1200°F for stainless steel/alloy sheath with stainless fins. Cataloged heaters are designed to operate within these parameters. The following charts will help guide the user in selecting proper watt density.

Allowable Sheath Watts/Square Inch at Various Air Velocities for Steel or Stainless Steel Finned THF heaters

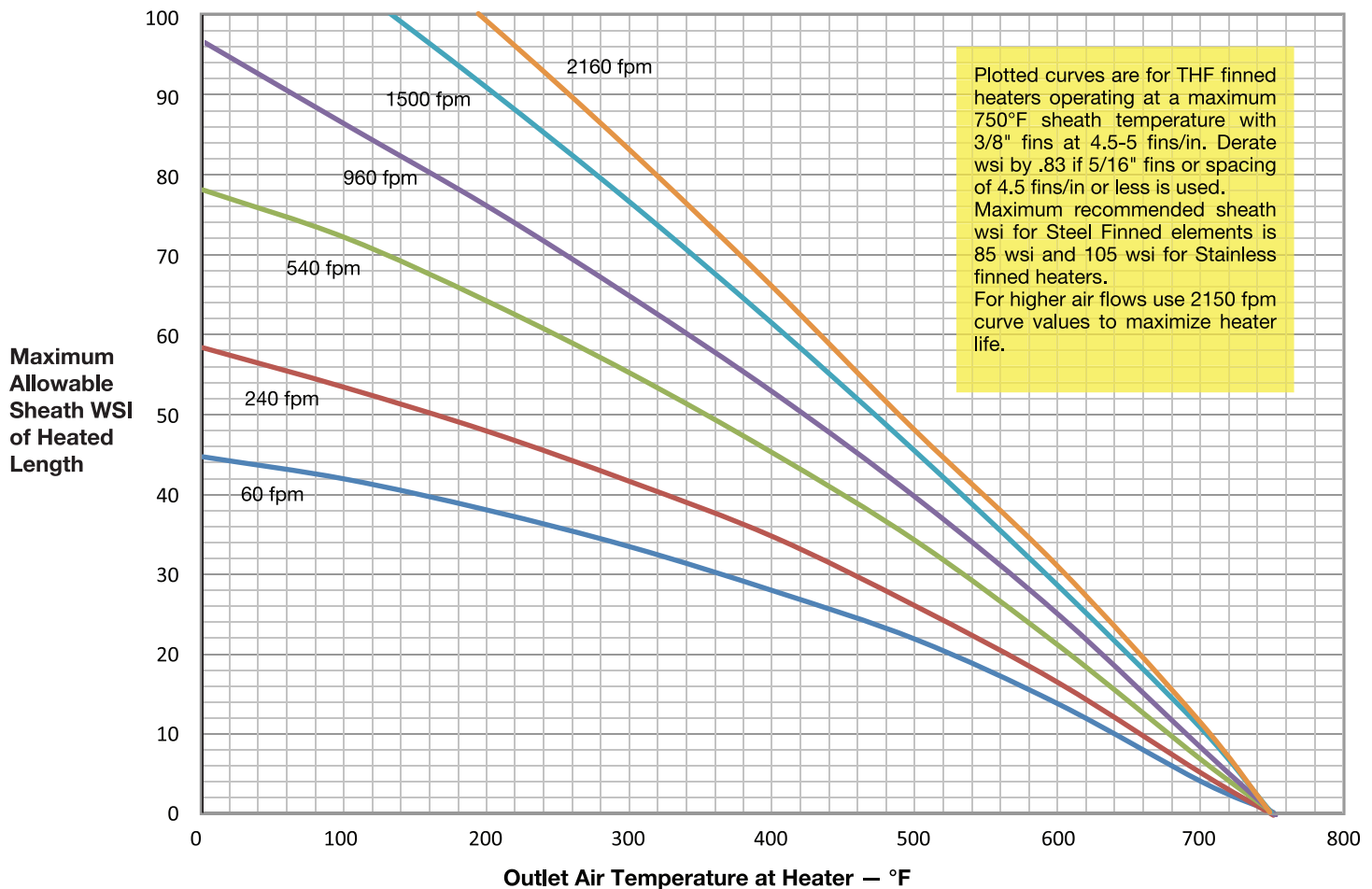

Chart 1 for steel (or SS) finned elements relates the maximum allowable sheath wsi to outlet air temperature that will be obtained at various air velocity levels.

These curves are for 750°F (or lower) sheath operating temperature.

The following Examples Illustrate the Graph's Use

Example 1

An application requires a heater to output 275°F air at an air velocity of 750 FPM. Entering the curves with 275°F, then up to 750 FPM level we find that a maximum of 62-64 wsi can be applied. Depending on voltage and space constraints either a .315 or .430 diameter catalog heater could be used.

Example 2

A curing oven needed 325°F outlet air at a minimum velocity of 1500 FPM. Entering chart at 325°F up to the 1500 FPM curve, we see that the heater could have a maximum of 70-72 sheath wsi. If a higher outlet air temperature is required, or if the airflow velocity is lower, then a reduced a sheath wsi would have to be specified.

Air Outlet Temperature vs Air Velocity
for various THF Sheath WSI Levels

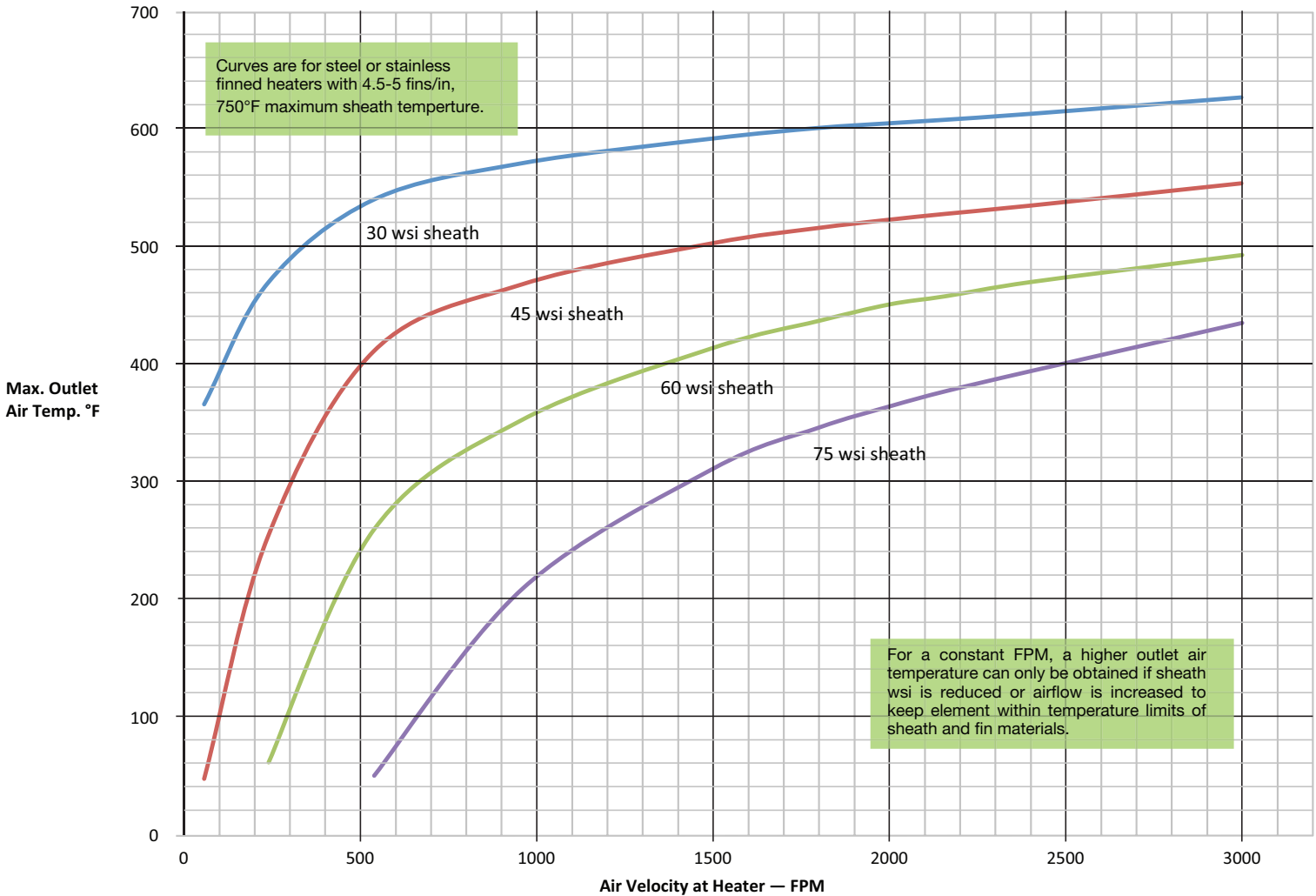

Chart 2 shows the relationship of maximum outlet air temperature obtained vs inlet air velocity at several sheath wsi levels.

This chart can be used for either steel or stainless steel finned elements operating at a maximum of 750°F and provides a way of establishing either airflow required or outlet temperature that will be obtained when sheath wsi is known for an application.

These curves show that to obtain a higher air outlet temperature at a constant FPM, the sheath wsi must be reduced to keep the element within the 750°F temperature limit of sheath & fin materials. These curves are for air entering a heater at or near ambient (60°-105°F).

**Sheath Temperature vs wsi for THF Finned Tubular Elements
in various velocities of forced air at 80°F**

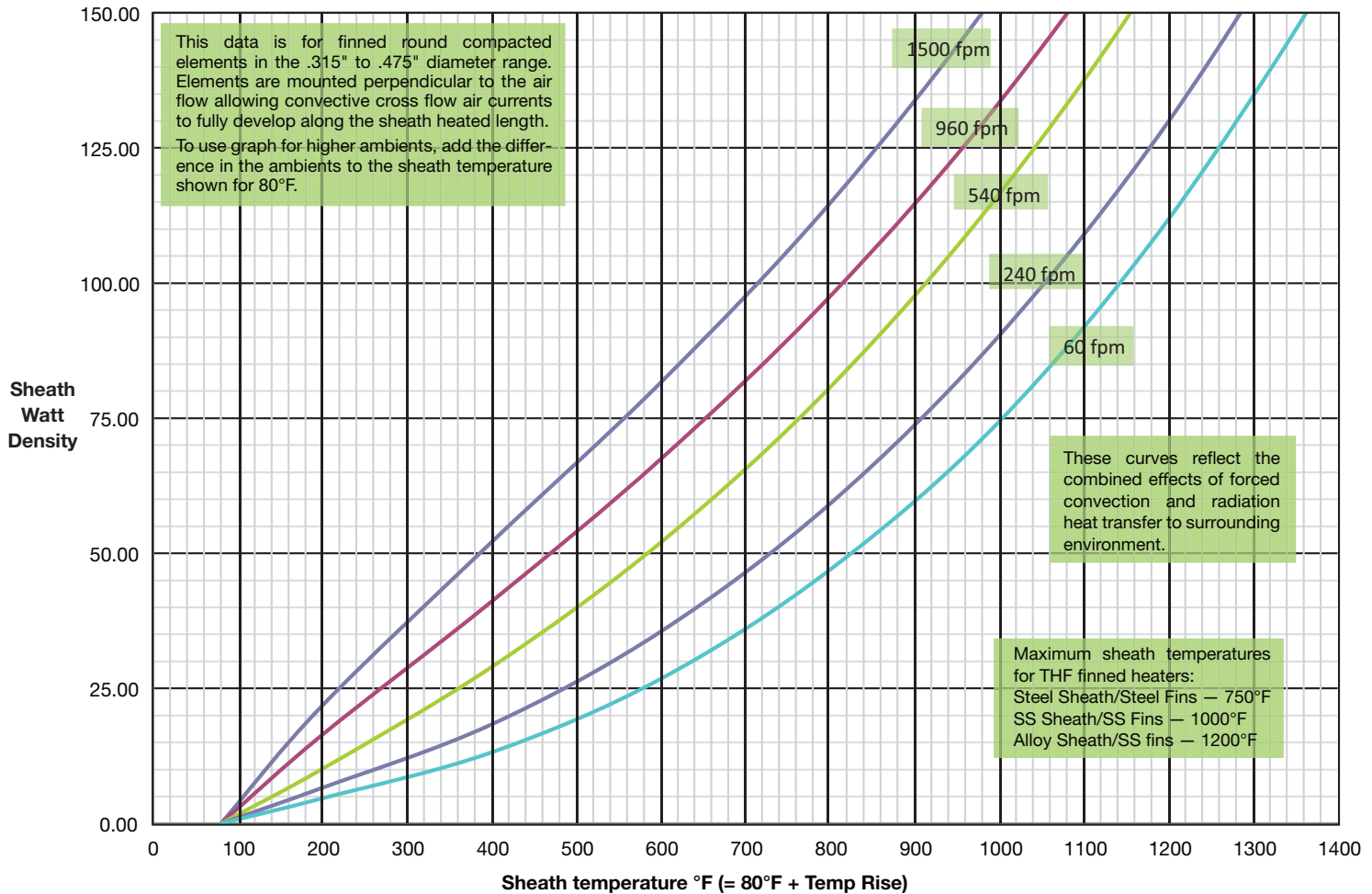

Chart 3 is a plot of sheath temperature and sheath watt density at various levels of inlet forced air at 80°F

It can be used to determine a maximum allowable sheath wsi for heating applications not restricted to the steel sheath limit of 750°. It can be used directly for most ambient air heating processes using Incoloy or Stainless Steel sheathed elements with stainless steel fins.

The following Example Illustrates the Graph's use when Operating in a Higher Ambient

Application

A recirculating process oven with organic vapors, moisture & other air contamination present, requires 500°F air at a minimum flow velocity of 900 FPM. Can a Stainless steel finned alloy sheathed heater at 80 wsi be used?

Using the Graph

Entering this chart at 900 FPM and 80 wsi, we find the sheath temperature when operating at 80°F ambient will be 700°F. The ambient temperature difference from the graph value of 80°F to the new higher 500°F ambient is 420°F (500-80). The new sheath temperature when operating in the 500°F ambient will be approximately 1120°F. (700 + 420). This is just 80° lower than the 1200°F limit for a stainless steel finned heater.

To conserve heater life it would be best to use a lower watt density & operate the heater at the lowest point possible given voltage, size, and construction constraints of the application. Consideration should be given to increasing the air velocity or using un-finned alloy sheath tubular heaters for this application. (See page 11-104)

Tech note: The reverse is true if element is operating in an ambient lower than 80°F. The sheath temperature would be reduced by the difference in the temperatures. The WSI range shown on the chart is approximately 4.25 times an unfinned tubular. The data has been confirmed by Tempco lab testing on .430 & .475 diameter finned heaters with 4.5-5 fins/in.

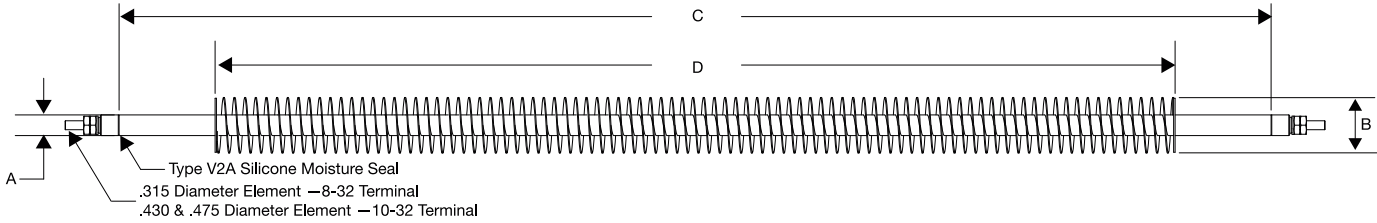

Standard (Non-Stock) Sizes and Ratings with Type T Termination

62-64 Sheath Watt Density (wsi)

Element Description	Dim. "A" inches	Dim. "B" inches	Dim. "C" inches	Dim. "D" inches	Watts	Part Number				
						120V	208V	240V	277V	480V
.315 Dia. Steel Element 5/16 Brazed Steel Fins 60 W/in	.315	.92	12½	8½	500	THF00321	—	—	—	—
	.315	.92	17½	13½	750	THF00322	THF00323	THF00324	—	—
	.315	.92	20½	16½	1000	THE00325	THF00326	THF00327	—	—
	.315	.92	29	25	1500	THF00328	THF00329	THF00330	—	—
	.315	.92	37	33	2000	THF00331	THF00332	THF00333	—	—
	.315	.92	54	50	3000	—	THF00334	THF00335	—	—
.430 Dia. Steel Element 3/8 Brazed Steel Fins 80 W/in	.430	1.15	17	13	1000	—	THF00338	THF00339	THF00340	THF00341
	.430	1.15	22¾	18¾	1500	—	THF00342	THF00343	THF00344	THF00345
	.430	1.15	29	25	2000	—	THF00346	THF00347	THF00348	THF00349
	.430	1.15	41	37	3000	—	THF00350	THF00351	THF00352	THF00353
	.430	1.15	53	49	4000	—	THF00354	THF00355	THF00356	THF00357
	.430	1.15	65	61	5000	—	THF00358	THF00359	THF00360	THF00361
.475 Dia. SS Element 3/8 SS Fins 90 W/in	.475	1.21	21½	17½	1500	—	THF00366	THF00367	THF00368	THF00369
	.475	1.21	26½	22½	2000	—	THF00370	THF00371	THF00372	THF00373
	.475	1.21	37	33	3000	—	THF00374	THF00375	THF00376	THF00377
	.475	1.21	48	44	4000	—	THF00378	THF00379	THF00380	THF00381
	.475	1.21	59	55	5000	—	THF00382	THF00383	THF00384	THF00385
	.475	1.21	70	66	6000	—	THF00386	THF00387	THF00388	THF00389
	.475	1.21	81	77	7000	—	THF00390	THF00391	THF00392	THF00393
	.475	1.21	92	88	8000	—	THF00394	THF00395	THF00396	THF00397

.315 diameter elements are typically used for air heating from ambient to 250/275°F at a minimum airflow of 700 FPM.

Maximum sheath temperature is 750°F. Reduced sheath watt density (wsi) required for lower airflows.

.430 diameter elements are typically used for air heating from ambient to 275/300°F at a minimum airflow of 750 FPM.

Maximum sheath temperature is 750°F. Reduced sheath watt density (wsi) required for lower airflows.

.475 diameter elements are typically used for air heating from ambient to 450/500°F at a minimum airflow of 1400 FPM.

Maximum sheath temperature is 1200°F. Reduced sheath watt density (wsi) required for lower airflows.

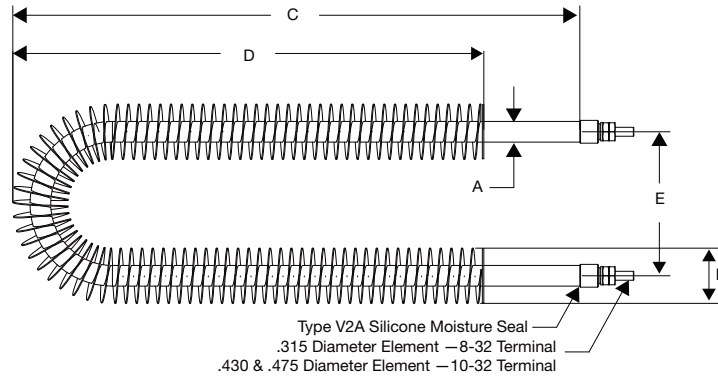

Standard (Non-Stock) Sizes and Ratings with Type T Termination

62-64 Sheath Watt Density (wsi)

Element Description	Dim. "A" inches	Dim. "B" inches	Dim. "C" inches	Dim. "D" inches	Dim. "E" inches	Watts	Part Number				
							120V	208V	240V	277V	480V
.315 Dia. Steel Element 5/16 Brazed Steel Fins 60 W/in	.315	.92	8¾	6¾	2	750	THF00398	THF00399	THF00400	—	—
	.315	.92	10¾	8¾	2	1000	THF00401	THF00402	THF00403	—	—
	.315	.92	14¾	12¾	2	1500	THE00404	THF00405	THF00406	—	—
	.315	.92	18½	16½	2	2000	THF00407	THF00408	THF00409	—	—
	.315	.92	26½	24½	2	3000	THF00410	THF00411	THF00412	—	—
	.315	.92	34½	32½	2	4000	—	THF00414	THF00415	—	—
.430 Dia. Steel Element 3/8 Brazed Steel Fins 80 W/in	.430	1.15	8½	6½	2	1000	—	THF00419	THF00420	THF00421	THF00422
	.430	1.15	11½	9½	2	1500	—	THF00423	THF00424	THF00425	THF00426
	.430	1.15	14½	12½	2	2000	—	THF00427	THF00428	THF00429	THF00430
	.430	1.15	21	19	2	3000	—	THF00431	THF00432	THF00433	THF00434
	.430	1.15	27	25	2	4000	—	THF00435	THF00436	THF00437	THF00438
	.430	1.15	32½	31	2	5000	—	THF00439	THF00440	THF00441	THF00442
.475 Dia. SS Element 3/8 SS Fins 90 W/in	.475	1.21	10½	8½	2½	1500	—	THF00447	THF00448	THF00449	THF00450
	.475	1.21	13¾	11¾	2½	2000	—	THF00451	THF00452	THF00453	THF00454
	.475	1.21	18½	16½	2½	3000	—	THF00455	THF00456	THF00457	THF00458
	.475	1.21	24	22	2½	4000	—	THF00459	THF00460	THF00461	THF00462
	.475	1.21	29½	27½	2½	5000	—	THF00463	THF00464	THF00465	THF00466
	.475	1.21	35	33	2½	6000	—	THF00467	THF00468	THF00469	THF00470
	.475	1.21	40½	38½	2½	7000	—	THF00471	THF00472	THF00473	THF00474
	.475	1.21	46	44	2½	8000	—	—	THF00475	THF00476	THF00477

.315 diameter elements are typically used for air heating from ambient to 250/275°F at a minimum airflow of 700 FPM.

Maximum sheath temperature is 750°F. Reduced sheath watt density (wsi) required for lower airflows

.430 diameter elements are typically used for air heating from ambient to 275/300°F at a minimum airflow of 750 FPM.

Maximum sheath temperature is 750°F. Reduced sheath watt density (wsi) required for lower airflows.

.475 diameter elements are typically used for air heating from ambient to 450/500°F at a minimum airflow of 1400 FPM.

Maximum sheath temperature is 1200°F. Reduced sheath watt density (wsi) required for lower airflows.

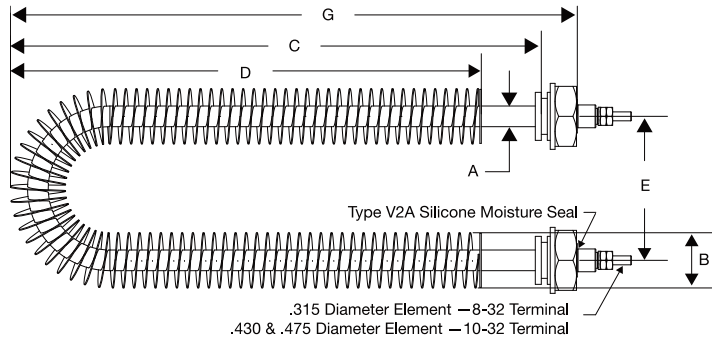

Standard (Non-Stock) Sizes and Ratings with Type T Termination 62-64 Sheath Watt Density (wsi)

Element Description	Dim. "A" inches	Dim. "B" inches	Dim. "C" inches	Dim. "D" inches	Dim. "E" inches	Dim. "G" inches	Watts	Part Number				
								120V	208V	240V	277V	480V
.315 Dia. Steel Element 5/16 Brazed Steel Fins 60 W/in	.315	.92	8¼	6¼	2	8¼	750	THF00478	THF00479	THF00480	—	—
	.315	.92	10¼	8¼	2	10¾	1000	THF00481	THF00482	THF00483	—	—
	.315	.92	14¼	12¼	2	14¾	1500	THE00484	THF00485	THF00486	—	—
	.315	.92	18	16½	2	18½	2000	THF00487	THF00488	THF00489	—	—
	.315	.92	26	24½	2	26½	3000	THF00490	THF00491	THF00492	—	—
	.315	.92	34	32½	2	34½	4000	—	THF00493	THF00494	—	—
.430 Dia. Steel Element 3/8 Brazed Steel Fins 80 W/in	.430	1.15	7¾	6½	2	8½	1000	—	THF00497	THF00498	THF00499	THF00500
	.430	1.15	10¾	9½	2	11½	1500	—	THF00501	THF00502	THF00503	THF00504
	.430	1.15	13¾	12½	2	14½	2000	—	THF00505	THF00506	THF00507	THF00508
	.430	1.15	20¼	19	2	21	3000	—	THF00509	THF00510	THF00511	THF00512
	.430	1.15	26¼	25	2	27	4000	—	THF00513	THF00514	THF00515	THF00516
	.430	1.15	32¼	31	2	33	5000	—	THF00517	THF00518	THF00519	THF00520
.475 Dia. SS Element 3/8 SS Fins 90 W/in	.475	1.21	9¾	8½	2½	10½	1500	—	THF00525	THF00526	THF00527	THF00528
	.475	1.21	12½	11¼	2½	13¼	2000	—	THF00529	THF00530	THF00531	THF00532
	.475	1.21	17¾	16½	2½	18½	3000	—	THF00533	THF00534	THF00535	THF00536
	.475	1.21	23¼	22	2½	24	4000	—	THF00537	THF00538	THF00539	THF00540
	.475	1.21	28¾	27½	2½	29½	5000	—	THF00541	THF00542	THF00543	THF00544
	.475	1.21	34¼	33	2½	35	6000	—	THF00545	THF00546	THF00547	THF00548
	.475	1.21	39¾	38½	2½	40½	7000	—	THF00549	THF00550	THF00551	THF00552
	.475	1.21	45¼	44	2½	46	8000	—	—	THF00553	THF00554	THF00555

.315 diameter elements are typically used for air heating from ambient to 250/275°F at a minimum airflow of 700 FPM.

Maximum sheath temperature is 750°F. Reduced sheath watt density (wsi) required for lower airflows.

.430 diameter elements are typically used for air heating from ambient to 275/300°F at a minimum airflow of 750 FPM.

Maximum sheath temperature is 750°F. Reduced sheath watt density (wsi) required for lower airflows.

.475 diameter elements are typically used for air heating from ambient to 450/500°F at a minimum airflow of 1400 FPM.

Maximum sheath temperature is 1200°F. Reduced sheath watt density (wsi) required for lower airflows.

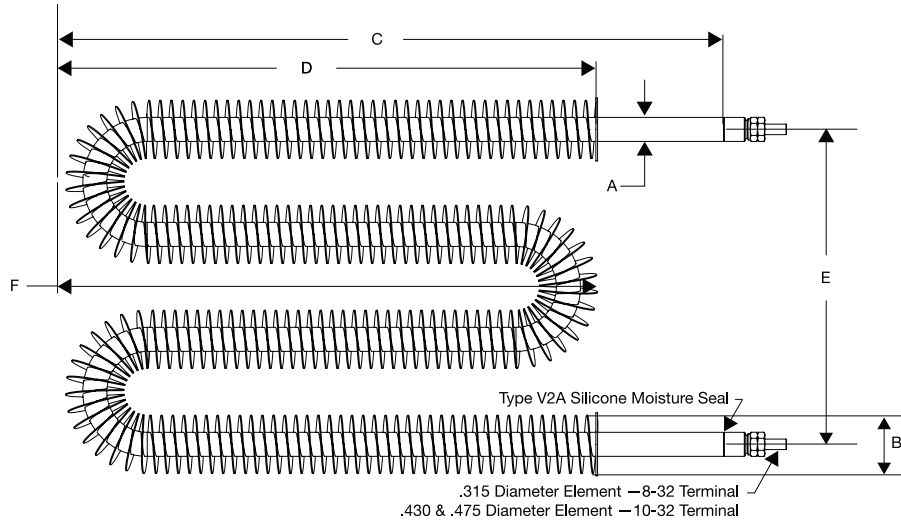

Standard (Non-Stock) Sizes and Ratings with Type T Termination
62-64 Sheath Watt Density (wsi)

Element Description	Dim. "A" inches	Dim. "B" inches	Dim. "C" inches	Dim. "D" inches	Dim. "E" inches	Dim. "F" inches	Watts	Part Number				
								120V	208V	240V	277V	480V
.315 Dia. Steel Element 5/16 Brazed Steel Fins 60 W/in	.315	.92	6¼	4¼	6	4¼	1000	THF00556	THF00557	THF00558	—	—
	.315	.92	8¼	6¼	6	6¼	1500	THF00559	THF00560	THF00561	—	—
	.315	.92	10¼	8¼	6	8¼	2000	THE00562	THF00563	THF00564	—	—
	.315	.92	14¼	12¼	6	12¼	3000	THF00565	THF00466	THF00567	—	—
	.315	.92	18¼	16¼	6	16¼	4000	THF00568	THF00569	THF00570	—	—
	.315	.92	22¼	20¼	6	20¼	5000	—	THF00571	THF00572	—	—
.430 Dia. Steel Element 3/8 Brazed Steel Fins 80 W/in	.430	1.15	8	6	7.5	6	2000	—	THF00575	THF00576	THF00577	THF00578
	.430	1.15	11	9	7.5	9	3000	—	THF00579	THF00580	THF00581	THF00582
	.430	1.15	14	12	7.5	12	4000	—	THF00583	THF00584	THF00585	THF00586
	.430	1.15	17	15	7.5	15	5000	—	THF00587	THF00588	THF00589	THF00590
	.430	1.15	20	18	7.5	18	6000	—	THF00591	THF00592	THF00593	THF00594
	.430	1.15	23	21	7.5	21	7000	—	THF00595	THF00596	THF00597	THF00598
.475 Dia. SS Element 3/8 SS Fins 90 W/in	.475	1.21	7½	5½	9	5½	2000	—	THF00602	THF00603	THF00604	THF00605
	.475	1.21	10	8	9	8	3000	—	THF00606	THF00607	THF00608	THF00609
	.475	1.21	12½	10½	9	10½	4000	—	THF00610	THF00611	THF00612	THF00613
	.475	1.21	15½	13½	9	13½	5000	—	THF00614	THF00615	THF00616	THF00617
	.475	1.21	18	16	9	16	6000	—	THF00618	THF00619	THF00620	THF00621
	.475	1.21	21	19	9	19	7000	—	THF00622	THF00623	THF00624	THF00625
	.475	1.21	24	22	9	22	8000	—	—	THF00626	THF00627	THF00628

.315 diameter elements are typically used for air heating from ambient to 250/275°F at a minimum airflow of 700 FPM.

Maximum sheath temperature is 750°F. Reduced sheath watt density (wsi) required for lower airflows

.430 diameter elements are typically used for air heating from ambient to 275/300°F at a minimum airflow of 750 FPM.

Maximum sheath temperature is 750°F. Reduced sheath watt density (wsi) required for lower airflows.

.475 diameter elements are typically used for air heating from ambient to 450/500°F at a minimum airflow of 1400 FPM.

Maximum sheath temperature is 1200°F. Reduced sheath watt density (wsi) required for lower airflows.

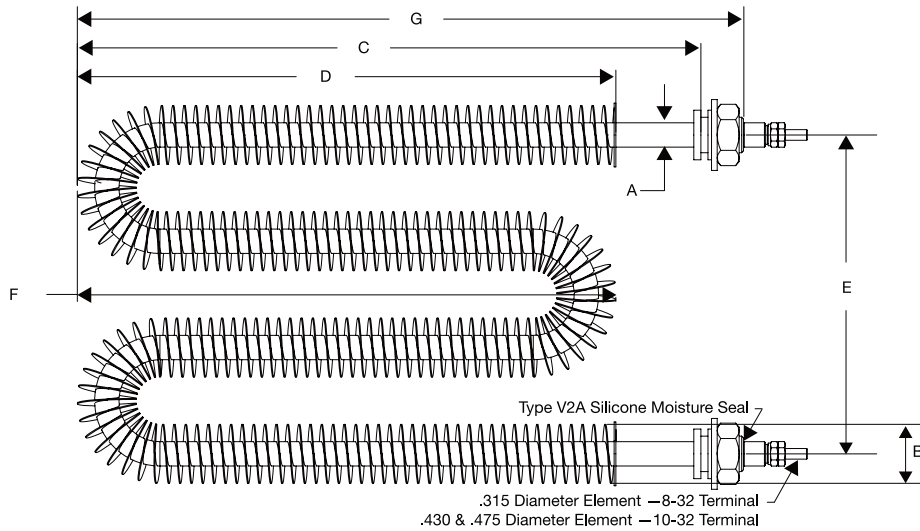

Standard (Non-Stock) Sizes and Ratings with Type T Termination 62-64 Sheath Watt Density (wsi)

Element Description	Dim. "A" inches	Dim. "B" inches	Dim. "C" inches	Dim. "D" inches	Dim. "E" inches	Dim. "F" inches	Dim. "G" inches	Watts	Part Number				
									120V	208V	240V	277V	480V
.315 Dia. Steel Element 5/16 Brazed Steel Fins 60 W/in	.315	.92	5 ³ / ₄	4 ¹ / ₄	6	4 ¹ / ₄	6 ¹ / ₄	1000	THF00629	THF00630	THF00631	—	—
	.315	.92	7 ³ / ₄	6 ¹ / ₄	6	6 ¹ / ₄	8 ¹ / ₄	1500	THF00632	THF00633	THF00634	—	—
	.315	.92	9 ³ / ₄	8 ¹ / ₄	6	8 ¹ / ₄	10 ¹ / ₄	2000	THF00635	THF00636	THF00637	—	—
	.315	.92	13 ³ / ₄	12 ¹ / ₄	6	12 ¹ / ₄	14 ¹ / ₄	3000	THF00638	THF00639	THF00640	—	—
	.315	.92	17 ³ / ₄	16 ¹ / ₄	6	16 ¹ / ₄	18 ¹ / ₄	4000	THF00641	THF00642	THF00643	—	—
	.315	.92	21 ³ / ₄	20 ¹ / ₄	6	20 ¹ / ₄	22 ¹ / ₄	5000	—	THF00644	THF00645	—	—
.430 Dia. Steel Element 3/8 Brazed Steel Fins 80 W/in	.430	1.15	7 ¹ / ₄	6	7.5	6	8	2000	—	THF00648	THF00649	THF00650	THF00651
	.430	1.15	10 ¹ / ₄	9	7.5	9	11	3000	—	THF00652	THF00653	THF00654	THF00655
	.430	1.15	13 ¹ / ₄	12	7.5	12	14	4000	—	THF00656	THF00657	THF00658	THF00659
	.430	1.15	16 ¹ / ₄	15	7.5	15	17	5000	—	THF00660	THF00661	THF00662	THF00663
	.430	1.15	19 ¹ / ₄	18	7.5	18	20	6000	—	THF00664	THF00665	THF00666	THF00667
	.430	1.15	22 ¹ / ₄	21	7.5	21	23	7000	—	THF00668	THF00669	THF00670	THF00671
.475 Dia. SS Element 3/8 SS Fins 90 W/in	.475	1.21	6 ³ / ₄	5 ¹ / ₂	9	5 ¹ / ₂	7 ¹ / ₂	2000	—	THF00675	THF00676	THF00677	THF00678
	.475	1.21	9 ¹ / ₄	8	9	8	10	3000	—	THF00679	THF00680	THF00681	THF00682
	.475	1.21	11 ³ / ₄	10 ¹ / ₂	9	10 ¹ / ₂	12 ¹ / ₂	4000	—	THF00683	THF00684	THF00685	THF00686
	.475	1.21	14 ³ / ₄	13 ¹ / ₂	9	13 ¹ / ₂	15 ¹ / ₂	5000	—	THF00687	THF00688	THF00689	THF00690
	.475	1.21	17 ¹ / ₄	16	9	16	18	6000	—	THF00691	THF00692	THF00693	THF00694
	.475	1.21	20 ¹ / ₄	19	9	19	21	7000	—	THF00695	THF00696	THF00697	THF00698
	.475	1.21	23 ¹ / ₄	22	9	22	8000	—	—	THF00699	THF00700	THF00701	THF00701

.315 diameter elements are typically used for air heating from ambient to 250/275°F at a minimum airflow of 700 FPM.

Maximum sheath temperature is 750°F. Reduced sheath watt density (wsi) required for lower airflows

.430 diameter elements are typically used for air heating from ambient to 275/300°F at a minimum airflow of 750 FPM.

Maximum sheath temperature is 750°F. Reduced sheath watt density (wsi) required for lower airflows.

.475 diameter elements are typically used for air heating from ambient to 450/500°F at a minimum airflow of 1400 FPM.

Maximum sheath temperature is 1200°F. Reduced sheath watt density (wsi) required for lower airflows.

Finned Duct Heaters can be found on Page 11-113A and 11-113B

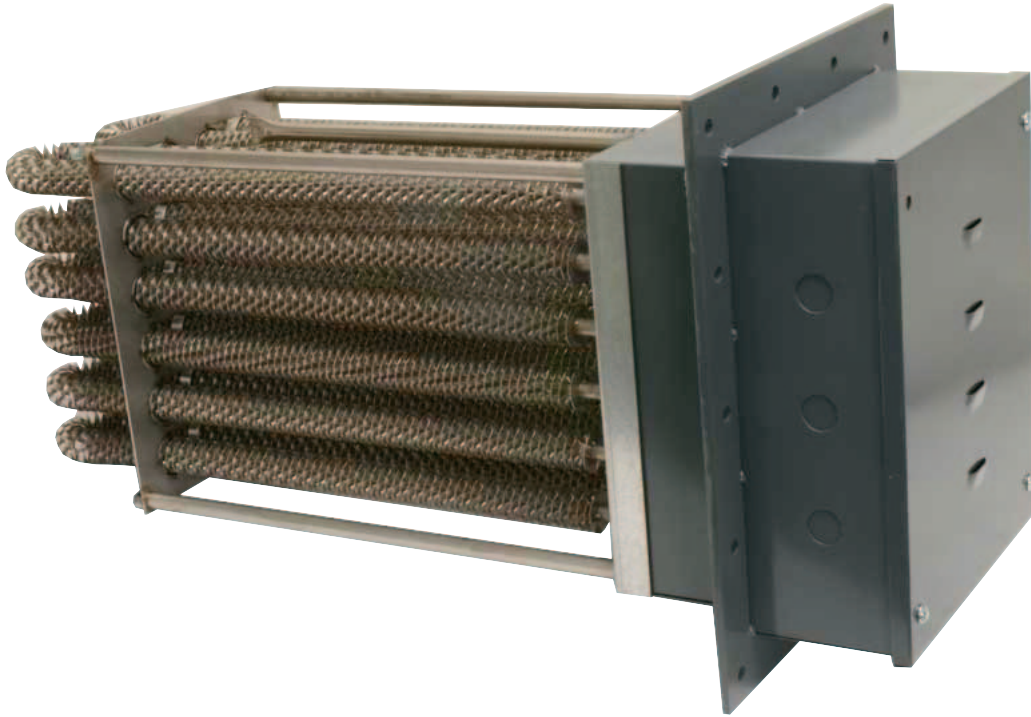

Tubular Heaters



Quote Request

Tubular Heater, Finned Tubular Heater and Single Ended Tubular Heater Quote Request
Made-To-Order Quote Request Form — Copy and Fax (630-350-0232) us your requirements.

Customer Drawing

Name _____
Company _____
Address _____

Phone _____ Fax _____
Email _____

Application Information

Describe in Detail _____

Air or Immersion _____
Maximum Load Temperature _____
Quantity _____

Specifications

Type: Standard _____ Finned _____ Single Ended _____
Sheath Material _____
Diameter _____ Fin Dia. *if applies* _____
Overall Sheath Length _____
Cold Section: 1st end _____ 2nd end _____
Watts _____ Volts _____
UL _____ cUL _____ CSA _____ CE _____
Termination Type _____ (Type T – standard screw)

Standard Options

Mounting: MC ___ LR ___ Location: _____ MF ___
Bulkhead Fittings ___ Material ___ Flange Type ___
Describe if Custom _____

Moisture Seals

Moisture Seals: None _____
Optional: Style SS: Type V2A _____ Type V2B _____
Style SER: Type R _____ Type R1 _____
Style SEH: Type V _____ Type V1 _____
Type M _____ Type H _____
Describe if Custom _____

Optional Sheath Surface Treatments

(For Incoloy® and Stainless Steel Sheath Elements only)
Passivation _____ Bright Annealing _____
Electro-Polishing _____
Other _____

Bends and Shapes

Standard Formation Code _____
Specify Letters and Corresponding Dimensions Below:

Number of Bends *if known*
Single/Multiple _____ Plane _____
Coils/Turns _____ Dia. _____
Circle: Full ___ Dia. ___ Partial ___ Degree ___
Describe if Custom: _____

⚠ WARNING: Cancer and Reproductive Harm - www.P65Warnings.ca.gov.

View Product Inventory @ www.tempco.com