

### Circulation Heaters

**Self-contained heating units designed for optimum operating efficiency and performance—  
Providing trouble-free service and application flexibility!**

All of the heat generated by the elements is immediately transferred to the medium being processed with minimal losses.

**Standard and optional features include...**

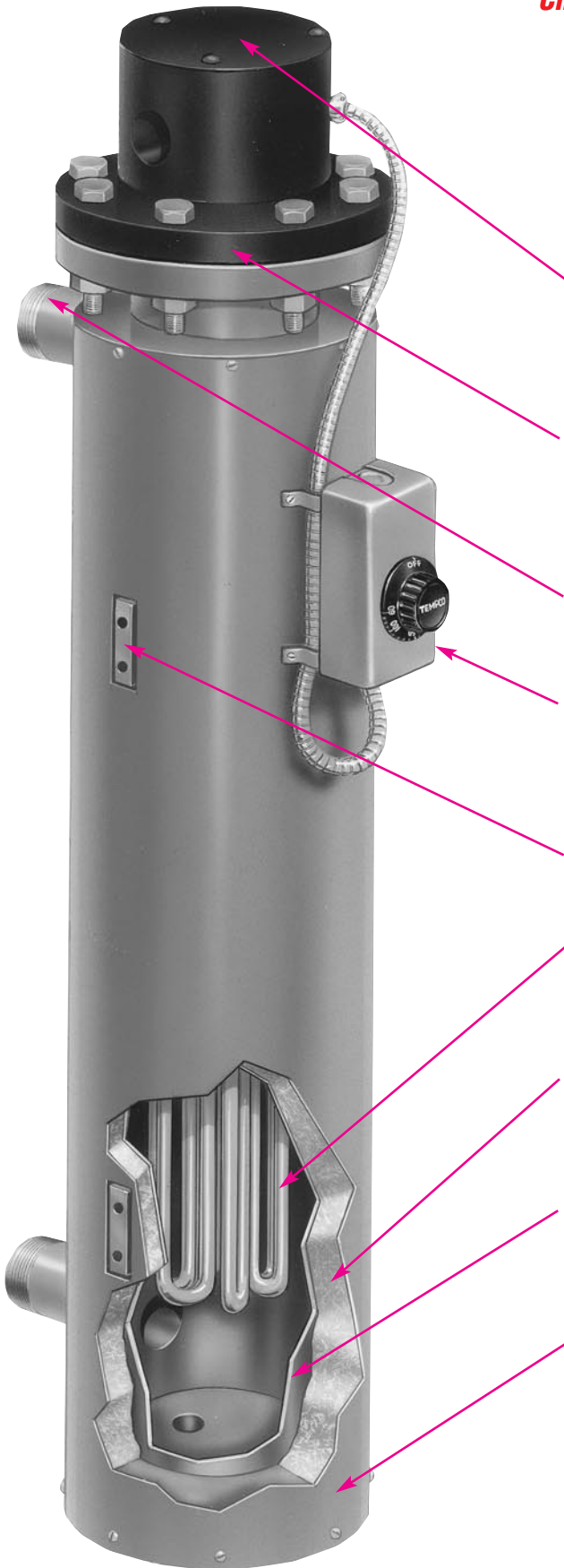

**A** General purpose (NEMA 1) terminal housing is standard. Moisture proof (NEMA 4) and/or explosion resistant (NEMA 7) housings are optional. A set of installation and maintenance instructions along with a wiring diagram can be found inside the terminal housing of each unit.

**B** Heating source—1-1/4" and 2-1/2" Screw Plug Heaters are used on smaller units. 3" to 14" size heaters use Flanged Immersion Heaters. The flanges are made from forged steel rated for 150 lbs with raised face. Supplied with threaded eyebolts for ease of handling and installation. Optional stainless steel flanges or 300 lb ratings available.

**C** Inlet-outlet connections are NPT pipe threads for 3" to 8" Circulation Heaters (flanges are optional). Standard inlet-outlet connections on 10" and larger units are 150 lb. rated flanges.

**D** Optional feature double-pole non-indicating bulb and capillary type thermostat can be located in the terminal box (standard) or attached to the insulation jacket as pictured. Solid state temperature controllers and indicating thermostats are available. Over-temperature protection can be provided by attaching a thermocouple to one of the elements.

**E** Threaded mounting lugs to support the unit are welded to the steel vessel. Custom supports can be designed to fit your structure.

**F** Wide selection of heating element sheath materials for maximum corrosion resistance to the medium being processed. On smaller circulation units with screw plug heaters, the element diameter is .315" or .475". On larger units with flanged heaters, the element diameter is .475".

**G** The vessel is surrounded with 1" thick insulation rated to 750°F (399°C) to minimize heat loss. Additional insulation or a high temperature ceramic fiber insulation is optional. Vessels can also be supplied uninsulated.

**H** Vessel material is SA53B or SA106B steel. Good for up to 750°F (399°C) operating temperature. For drainage and cleaning purposes, a drain plug is located in the base of the tank. Optional: Stainless steel vessel.

**I** Outer stainless steel sheet metal jacket protects the insulation from the environment and keeps it dry. Optional: Stainless steel outer jacket with a weather-tight seal.



**Note: Branch Circuit Wiring:** Flange heater elements are wired into branch circuits having a maximum current of 48 Amps. The number of circuits is listed next to the heater's voltage and phase in the standard sizes and ratings chart. For different circuit wiring configurations, consult Tempco.

### Checklist — Selecting the Proper Circulation Heater

#### ☑ Determine a Safe and Efficient Element Watt Density

**Element Watt Density** is the wattage dissipated per square inch of the element sheath surface and is calculated with the following formula:

$$\text{Watt Density} = \frac{\text{element wattage}}{\pi \times \text{element dia.} \times \text{element heated length}}$$

For a particular application, element watt density will govern element sheath temperature. Factors to consider when choosing a suitable watt density are:

1. Many materials are heat sensitive and can decompose or be damaged if the element is running too hot.
2. Air and other gases that are poor conductors of heat require watt densities matched to the velocity of the gas flow to prevent element overheating.
3. Mineral deposits when heating hard water and cleaning solutions can build up on the element sheath, acting as a heat insulator and raising the internal element temperature. If these deposits cannot be periodically removed, use a lower watt density element to increase heater life expectancy.

#### ☑ Select the Element Sheath Material

##### Sheath Material Selection

**CORROSION.** In addition to selecting a sheath material that is compatible with the heated medium, other factors that affect corrosion need to be considered:

1. **The temperature of the corrodent** — As temperature increases the degree of corrosion increases. Also remember that usually the element temperature is higher than the material it is heating.
2. **The degree of aeration to which a corrodent is exposed** — Stagnant conditions can deprive the stainless steels of oxygen, which is required to maintain their corrosion resistant surface.
3. **Velocity of the corrodent** — Increased velocity can increase the corrosion rate.



**Note:** See pages 16-12 through 16-20 for the recommended sheath materials for many immersion heating applications. If you are purchasing the material you are heating, check with the supplier for their recommendations.

##### Standard Element Sheath Materials

**Incoloy® 800** — A Nickel (30-35%), Chromium (19-23%), Iron alloy. The high nickel content of this alloy contributes to its resistance to scaling and corrosion. Used in air heating (also see Incoloy® 840) and immersion heating of potable water and other liquids that are not corrosive to an Incoloy® 800 sheath.

**Low Carbon Steel** — Applications include fluid heat transfer media, tar, high to low viscosity petroleum oils, asphalt, wax, molten salt, and other solutions not corrosive to a steel sheath.

**316 Stainless Steel** — A Chromium (16-18%), Nickel (11-14%), Iron Alloy with Molybdenum (2-3%) added to improve corrosion resistance in certain environments, especially those that would tend to cause pitting due to the presence of chlorides. Applications include deionized water.

**Copper** — Mainly used in clean water heating for washrooms, showers, rinse tanks and freeze protection of storage tanks.

##### Optional Element Sheath Materials

**304 Stainless Steel** — A Chromium (18-20%), Nickel (8-11%), Iron Alloy used in the food industry, sterilizing solutions, air heating and many organic and inorganic chemicals.

**321 Stainless Steel** — A Chromium (17-20%), Nickel (9-13%), Iron Alloy modified with the addition of titanium to prevent carbide precipitation and the resulting intergranular corrosion that can take place in certain mediums when operating in the 800-1200°F (427-649°C) temperature range.

**Incoloy® 840** — A Nickel (18-20%), Chromium (18-22%), Iron alloy. Incoloy 840 has about 10% less nickel than Incoloy 800. Used in many air heating applications where it has exhibited superior oxidation resistance at less cost than Incoloy 800.

**Incoloy® 825** — A Nickel (38-46%), Chromium (19.5-23.5%), Molybdenum (2-3%) Iron alloy. Consult Tempco for more information.

### Surface Treatments for Stainless Steel and Incoloy® Elements and other Wetted Parts to Improve Corrosion Resistance

Flanged Immersion Heater surfaces in contact with the material being heated can be passivated or electro-polished to improve their resistance to corrosion.

**Passivation** removes surface contamination, usually iron, so that the optimum corrosion resistance of the stainless steel is maintained. Surface contamination would come from the small amount of steel that may be worn off a tool during the manufacturing process. Passivating is accomplished by dipping the heater in a warm solution of nitric acid.

**Electro-Polishing** is an electrochemical process that removes surface imperfections and contaminants, enhancing the corrosion resisting ability of the stainless steels. The resultant surface is clean, smooth and bright. Many medical and food applications require this finish.



### Checklist – Selecting the Proper Circulation Heater, *continued*

#### Standard Terminal Housings

##### **Terminal Housings**

Tempco Circulation Heaters are supplied with a **General Purpose Housing** (NEMA 1) as standard unless otherwise specified.

Additional housing types include:

**Moisture Resistant** (NEMA 4)

**Explosion Resistant** (NEMA 7)

**Moisture/Explosion Resistant** (NEMA 4/7).

Descriptions and dimensions of housings for circulation heaters with screw plugs can be found on page 11-4, and for flange heaters on pages 11-26 and 11-27. If none of these housings meet the size, construction or other criteria of your application, consult Tempco with your requirements.



Explosion resistant terminal housings are intended to provide containment of an explosion in the enclosure only. No portion of the heater assembly outside the enclosure is covered under this NEMA rating.

Abnormal use of a heater which results in excessive temperature can create hazardous conditions such as a fire. Never perform any type of service nor remove the housing cover prior to disconnecting all electrical power to the heater.



#### **Optional Terminal Housing Standoff Construction**

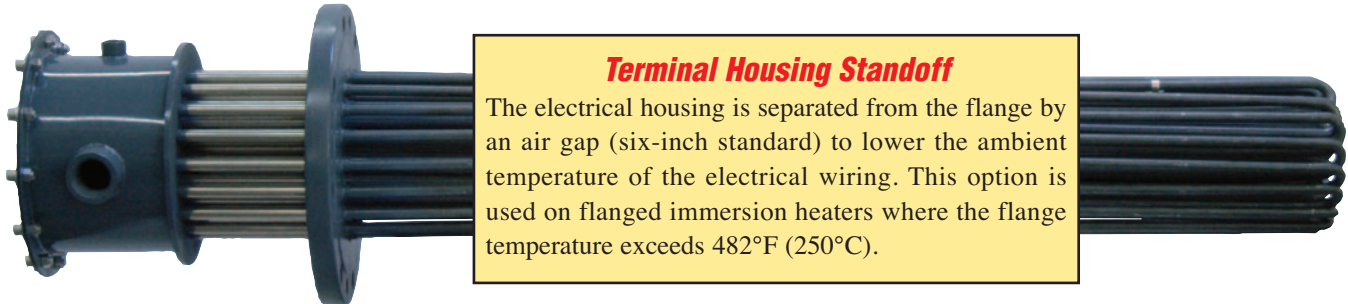

#### **Optional Circulation Heater Features**

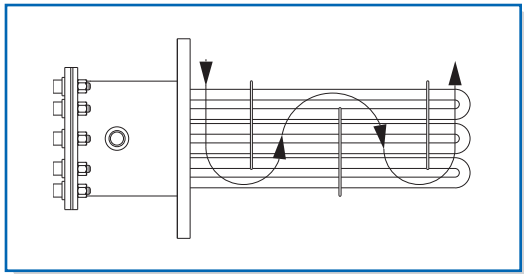

##### **Flow Control Baffles**

Used on circulation tank heaters to aid heat transfer by forcing the liquid or gas back and forth across the elements. Baffles can be custom designed and positioned for your application.

### Temperature Control

#### Thermostats

Thermostats are an optional feature on flanged immersion heaters. This type of control operates by expansion and contraction of a liquid in response to temperature change. Liquid contained within the sensing bulb and capillary flexes a diaphragm, causing the opening and closing of a snap action switch. For heating applications the contacts are normally closed and open on temperature rise.

#### Installation Warnings and Recommendations



1. Do not use the thermostat as a power switch. Use some other means of disconnecting power to the heater for servicing.
2. A Thermostat is not a fail-safe device. Use an approved high temperature limit control and/or pressure limit control for safe operation.
3. Avoid kinking or bending the capillary tube too sharply as this will alter the calibration and/or render the thermostat inoperable.
4. Excess capillary tube should be coiled neatly in junction box.
5. The capillary tube must never touch the thermostat contacts as this will create an electrical short capable of harming personnel and/or equipment.

#### Thermocouples

Type J or Type K thermocouples can be supplied for process temperature or over-temperature control. Type J is reliable and accurate for temperatures up to 1000°F (538°C). Type K should be used for higher temperatures.

For measuring process temperatures the thermocouple can be mounted in a thermowell in the center of the element bundle. Note that a location somewhere away from the heater may give a more accurate measurement of process temperature.

For over-temperature protection the thermocouple is usually attached to one of the elements (Figure A) and any unusual rise in element temperature would shut the heater down. This thermocouple may also be mounted in a thermowell (Figure B), which is then attached to one of the heating elements if desired. This protects the thermocouple from the solution being heated and allows you to replace it without removing the heater, but does increase its response time.

Temperature and over-temperature controls for using the signal generated by thermocouples and how to select the best control for your application can be found in Section 13.

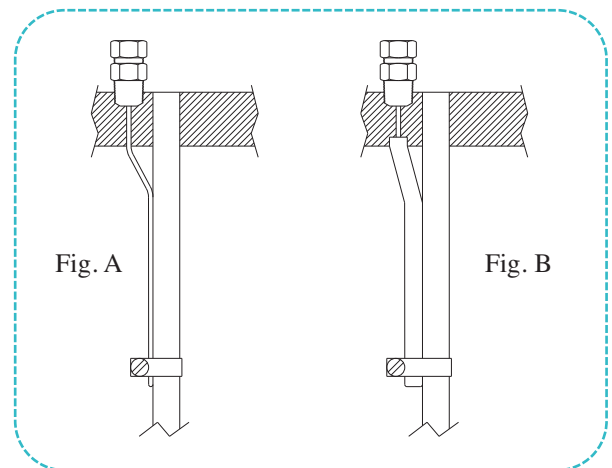

### Series CHX-100, CHX-200 and CHX-300 Circulation Heaters — See Pages 3-12 through 3-17

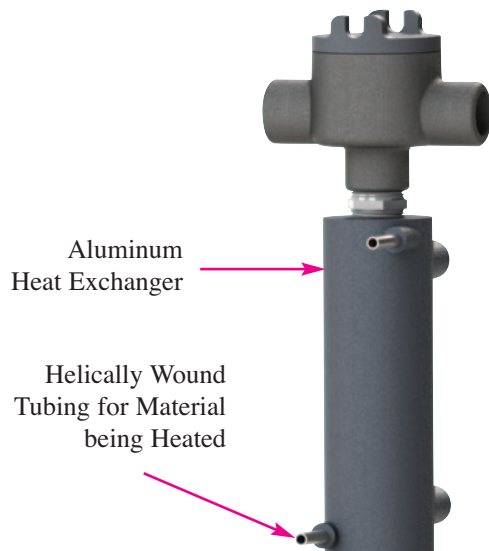

#### Construction

Series CHX circulation heaters are compact lightweight units used for heating gases or liquids. The material being heated is pumped through the coiled seamless 316 SS tubing which has been cast into an aluminum body which acts as the heat exchanger. A replaceable Hi-Density cartridge set into a hole bored into the aluminum is the heat source for the CHX-100, and a tubular heating element is the heat source for the CHX-200 and CHX-300. The material being heated never comes into contact with the heating element.



### Circulation Heater Installation Recommendations

*Tempco Circulation Heaters will have a long life and provide dependable, trouble-free service if properly installed, operated and maintained as per the following recommendations:*

#### Installation

1. Flange heaters are supplied with two drilled and tapped holes for threaded eye bolts, providing ease of handling during installation and flange removal during maintenance cleaning or heater replacement.
2. Replacement of heater is inevitable. Therefore, provide adequate space for installation, allowing ample room to remove the flange heater for cleaning or replacement.
3. In applications requiring the circulation heater to be fed by an inline pump, install the pump at the inlet end.
4. To maintain the lowest possible temperature at the terminal box, place the outlet at the end opposite to the terminal box. If your process temperature is circulating at 450°F (232°C) or above (at the nozzle closest to the flange), stand-off terminal box construction is recommended.
5. To prevent temperature and/or pressure buildup on closed loop circulation heater systems, adequate and strategically located thermocouples for temperature controllers and pressure relief valves should be installed. Never over-rate pressure relief valves beyond the pressure temperature rating of the flange being used.
6. During the process cycle, flow rate of the medium being heated should never be interrupted or reduced, thus creating an overheating condition. Excess temperature can result in damage to the medium being processed and premature heater failure.
7. Make sure that your circulation heater is equipped with the proper terminal housing for the environment in which the heater is being used. NEMA 1—General purpose, NEMA 4—Moisture resistant, and NEMA 7—Explosion resistant.



#### Wiring

1. All heater installations must be properly earth grounded to eliminate electric shock hazard. Electrical wiring must be in accordance with Local and/or National Electrical Codes.
2. Circulation heaters are supplied standard with NEMA 1 terminal housings. All power to heaters must be disconnected before removing the terminal housing cover and performing any type of service.
3. Electrical connections on heater terminals must be kept tight. Loose connections will create arcing, over-heating, and eventually will destroy the heater terminal and cause premature heater failure.
4. If the amperage rating of your circulation heater exceeds the amperage capacity of the supplied thermostat, mercury relays or magnetic contactors should be used with the thermostat. See pages 13-92 through 13-96.
5. Over-temperature protection thermocouples require a separate conduit to the control panel for the thermocouple wire.
6. Tempco offers a large selection of Power Control Panels for circulation heaters. See pages 13-56 through 13-63.

#### Maintenance

1. Never perform any type of service on the unit prior to disconnecting all electrical power and shutting off all intake lines.
2. Remove sludge deposits through the drain plug.
3. Check flange bolts for tightness.
4. Check terminal connections for tightness.
5. Check thermocouple or thermostat bulb for response to temperature changes. If defective, replace immediately.
6. Check for leaks.
7. Depending on operating conditions and medium being processed, the flange or screw plug heater should be periodically removed for physical inspection and cleaning of the element bundle.

#### Vertical Mounting—Liquids

With terminal housing up and inlet pipe on the bottom, the heating elements will be immersed at all times to prevent premature failure.



#### Horizontal Mounting—Liquids and Gases

Always mount heater with inlet-outlet pipes facing up to ensure the heating elements will be immersed at all times to prevent premature failure. For liquid heating, outlet may be at either end. When heating gases the inlet should be closest to the terminal enclosure to minimize terminal box wiring temperatures.

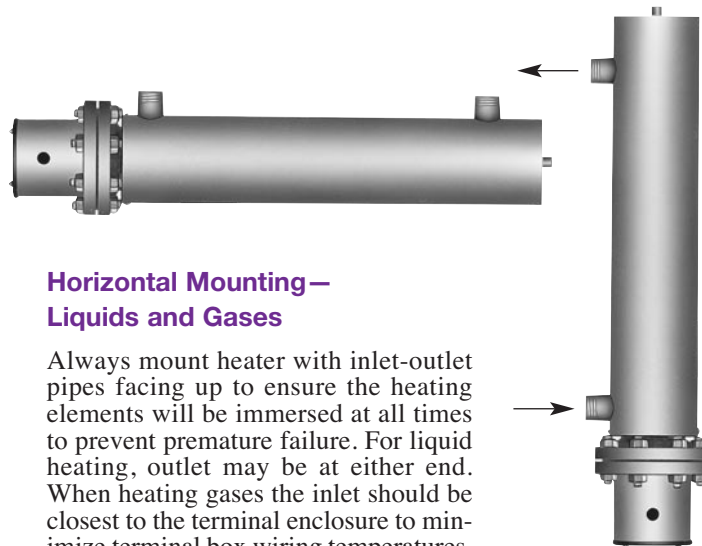

#### Vertical Mounting—Gases

Mount with terminal enclosure and inlet pipe at bottom of tank to minimize terminal box wiring temperatures.

### Circulation Tank Assembly Maximum Immersed Element Length

Standard circulation heaters shown in the tables on pages 11-51 through 11-69 have element immersion lengths determined by the element wattage and element watt density. The screw plug or flange heater containing the elements is matched to a standard circulation heater tank assembly to assure proper heat transfer and heated material flow. When designing a system with a heater not

shown on these pages the table below can be used to select a tank size based on the calculated immersion length. If a standard tank size is not suitable for your installation, Tempco will design and manufacture a custom tank and heater assembly to satisfy the requirements of your application.

Nominal Pipe Size	Dimension Drawing Number	Maximum Immersed Element length	
		in	mm
1 1/4" NPT	1.1	18.0	457
	1.2	26.0	660
2 1/2" NPT	2.1	25.5	648
	2.2	35.5	902
	2.3	48.0	1219
3" Flange	3.1	28.0	711
	3.2	38.0	965
	3.3	50.5	1283
4" Flange	4.1	26.5	673
	4.2	37.0	940
	4.3	58.0	1473
	4.4	79.0	2007
5" Flange	5.1	36.0	914
	5.2	43.0	1092
	5.3	54.5	1384
	5.4	68.0	1727
	5.5	85.0	2159
6" Flange	6.1	26.5	673
	6.2	37.0	940
	6.3	58.0	1473
	6.4	79.0	2007

Nominal Pipe Size	Dimension Drawing Number	Maximum Immersed Element length	
		in	mm
8" Flange	8.1	32.5	826
	8.2	40.5	1029
	8.3	47.5	1207
	8.4	55.0	1397
	8.5	64.5	1638
	8.6	73.5	1867
	8.7	83.5	2121
10" Flange	10.1	60.0	1524
	10.2	67.0	1702
	10.3	73.0	1854
	10.4	82.0	2083
	10.5	90.0	2286
12" Flange	12.1	59.0	1499
	12.2	66.5	1689
	12.3	74.0	1880
	12.4	81.5	2070
	12.5	89.0	2261
14" Flange	14.1	58.0	1473
	14.2	65.5	1664
	14.3	73.0	1854
	14.4	80.5	2045
	14.5	88.0	2235

### Standard (Non-Stock) Circulation Heaters

**8 watts/in<sup>2</sup> (1.3 watts/cm<sup>2</sup>) — Typical Applications: Fuel Oils (Bunker C and Number 6)**

- \* Steel Screw Plug and Steel 150-lb Flanged Heater Sizes
- \* Steel Sheath Heating Elements
- \* Steel Tank
- \* NEMA 1 Terminal Housing

**NOTE:** 3-Phase only. Cannot be rewired for single phase.

Nominal Pipe Size	Dimensional Drawing Number	KW	Part Number					Approximate Net Weight	
			120V	240V-1Ph (C*)	240V-3Ph (C*)	480V-1Ph (C*)	480V-3Ph (C*)	lbs	kgs
2 1/2" NPT	2.2	2	—	—	CHF01100 (1)	—	CHF01101 (1)	37	17
3 elements	2.3	3	—	—	CHF01102 (1)	—	CHF01103 (1)	46	21
3" — 150lb	3.2	2	—	—	CHF01104 (1)	—	CHF01105 (1)	62	28
3 elements	3.3	3	—	—	CHF01106 (1)	—	CHF01107 (1)	76	34

(C\*) = Number of Branch Circuits per heater

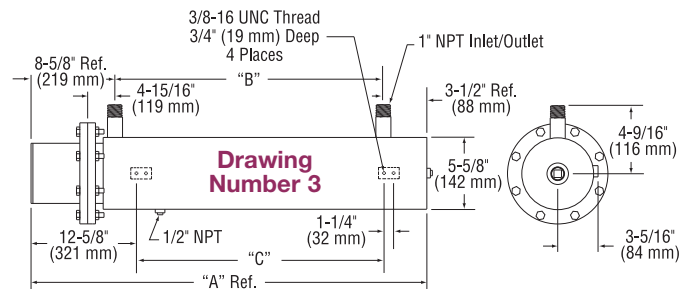
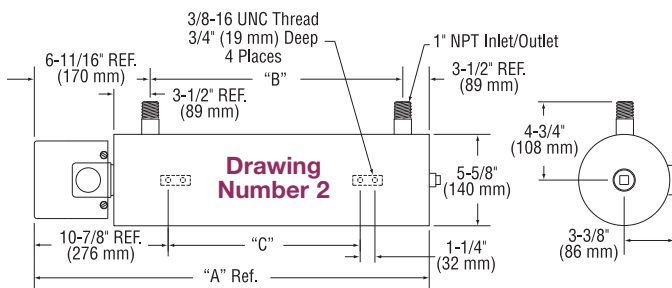

### Dimensional Drawing Number

Drawing Number	"A"		"B"		"C"	
	in	mm	in	mm	in	mm
2.2	42-11/16	1084	32-1/2	826	26-1/2	673
2.3	55-3/16	1402	45	1143	39	991
3.2	44-5/8	1133	32-1/2	826	26-1/2	673
3.3	57-1/8	1451	45	1143	39	991

### Ordering Information

See Page 11-69.

**CONTINUED** →

### Standard (Non-Stock) Circulation Heaters

Continued from previous page...

**8 watts/in<sup>2</sup> (1.3 watts/cm<sup>2</sup>) — Typical Applications: Fuel Oils (Bunker C and Number 6)**

- \* Steel Screw Plug and Steel 150-lb Flanged Heater Sizes
- \* Steel Tank

- \* Steel Sheath Heating Elements
- \* NEMA 1 Terminal Housing

**NOTE:** 3-Phase only. Cannot be rewired for single phase.

Nominal Pipe Size	Dimensional Drawing Number	KW	Part Number					Approximate Net Weight	
			120V	240V-1Ph (C*)	240V-3Ph (C*)	480V-1Ph (C*)	480V-3Ph (C*)	lbs	kgs
4" — 150lb 6 elements	4.3	5	—	—	CHF01108 (1)	—	CHF01109 (1)	117	53
	4.3	6	—	—	CHF01110 (1)	—	CHF01111 (1)	120	54
	4.4	8	—	—	CHF01112 (1)	—	CHF01113 (1)	147	67
	4.4	10	—	—	CHF01114 (1)	—	CHF01115 (1)	151	68
5" — 150lb 6 elements	5.2	5	—	—	CHF01116 (1)	—	CHF01117 (1)	128	58
	5.3	6	—	—	CHF01118 (1)	—	CHF01119 (1)	146	66
	5.4	8	—	—	CHF01120 (1)	—	CHF01121 (1)	172	78
	5.5	10	—	—	CHF01122 (1)	—	CHF01123 (1)	192	87
5" — 150lb 9 elements	5.2	7.5	—	—	CHF01124 (1)	—	CHF01125 (1)	135	61
	5.3	9	—	—	CHF01126 (1)	—	CHF01127 (1)	154	70
	5.4	12	—	—	CHF01128 (1)	—	CHF01129 (1)	183	83
	5.5	15	—	—	CHF01130 (1)	—	CHF01131 (1)	205	93
6" — 150lb 12 elements	6.2	8	—	—	CHF01132 (1)	—	CHF01133 (1)	157	71
	6.3	10	—	—	CHF01134 (1)	—	CHF01135 (1)	197	80
	6.3	12	—	—	CHF01136 (1)	—	CHF01137 (1)	202	92
	6.4	16.5	—	—	CHF01138 (1)	—	CHF01139 (1)	249	113
	6.4	20	—	—	CHF01140 (1)	—	CHF01141 (1)	257	117
6" — 150lb 15 elements	6.2	10	—	—	CHF01142 (1)	—	CHF01143 (1)	163	74
	6.3	12.5	—	—	CHF01144 (1)	—	CHF01145 (1)	204	93
	6.3	15	—	—	CHF01146 (1)	—	CHF01147 (1)	211	96
	6.4	21	—	—	CHF01148 (5)	—	CHF01149 (1)	260	118
	6.4	25	—	—	CHF01150 (5)	—	CHF01151 (1)	273	124
8" — 150lb 18 elements	8.3	12.5	—	—	CHF01152 (1)	—	CHF01153 (1)	272	123
	8.4	16.5	—	—	CHF01154 (1)	—	CHF01155 (1)	300	136
	8.5	20	—	—	CHF01156 (1)	—	CHF01157 (1)	334	151
	8.6	24	—	—	CHF01158 (2)	—	CHF01159 (1)	367	166
	8.7	27	—	—	CHF01160 (2)	—	CHF01161 (1)	402	182
8" — 150lb 24 elements	8.3	17	—	—	CHF01162 (1)	—	CHF01163 (1)	287	130
	8.4	22	—	—	CHF01164 (2)	—	CHF01165 (1)	318	144
	8.5	27	—	—	CHF01166 (2)	—	CHF01167 (1)	356	161
	8.6	32	—	—	CHF01168 (2)	—	CHF01169 (1)	386	175
	8.7	36	—	—	CHF01170 (2)	—	CHF01171 (1)	428	194
10" — 150lb 27 elements	10.3	30	—	—	CHF01172 (3)	—	CHF01173 (1)	537	244
	10.4	35	—	—	CHF01174 (3)	—	CHF01175 (1)	580	263
	10.5	40	—	—	CHF01176 (3)	—	CHF01177 (1)	623	283
12" — 150lb 36 elements	12.4	47	—	—	CHF01178 (3)	—	CHF01179 (2)	751	341
	12.5	54	—	—	CHF01180 (3)	—	CHF01181 (2)	793	360
14" — 150lb 45 elements	14.4	60	—	—	CHF01182 (3)	—	CHF01183 (3)	885	401
	14.5	67	—	—	CHF01184 (5)	—	CHF01185 (3)	941	427

(C\*) = Number of Branch Circuits per heater

**NOTE:** Nominal Pipe Size 8" and larger are 7 watts/in<sup>2</sup> (1.1 watts/cm<sup>2</sup>)

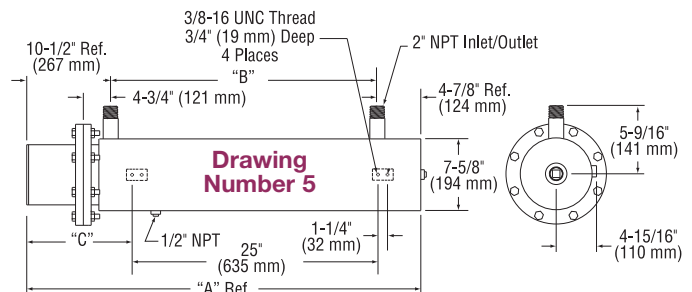
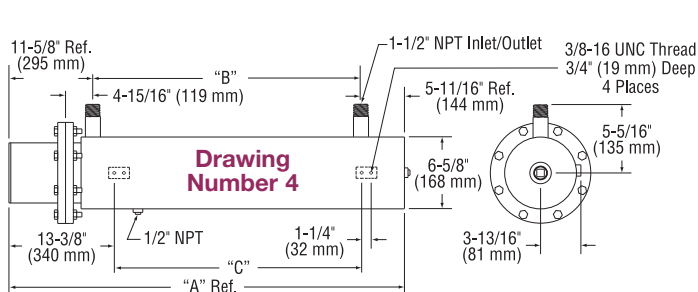

### Standard (Non-Stock) Circulation Heaters

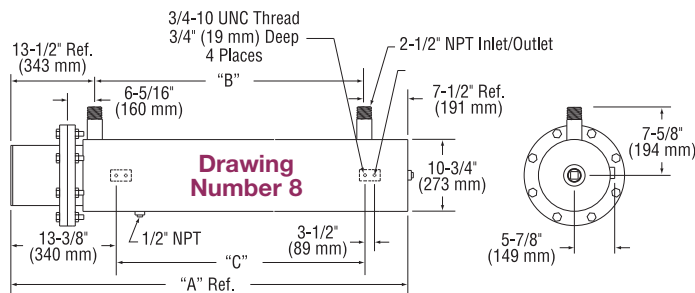
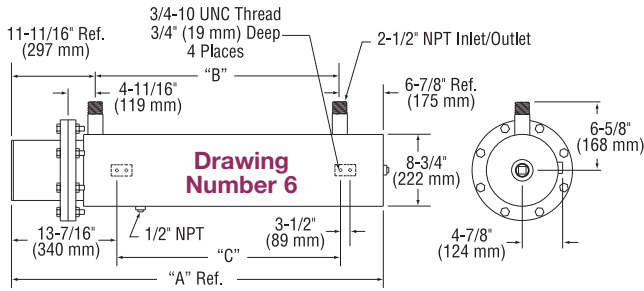

### Dimensional Drawing Number

Drawing Number	"A"		"B"		"C"	
	in	mm	in	mm	in	mm
4.3	69-5/16	1761	52	1321	48-1/2	1232
4.4	90-5/16	2294	73	1854	69-1/2	1765
5.2	52-3/8	1330	37	940	15-1/4	387
5.3	63-7/8	1622	48-1/2	1232	21	533
5.4	77-1/4	1962	61-7/8	1572	27-1/2	698
5.5	90-1/4	2292	74-7/8	1902	34-1/4	870
6.2	49-9/16	1259	31	787	27-1/2	699
6.3	70-9/16	1792	52	1321	48-1/2	1232
6.4	91-9/16	2326	73	1854	69-1/2	1765
8.3	60-3/4	1543	39-11/16	1008	36-3/16	919
8.4	68-3/4	1746	47-5/16	1202	43-13/16	1113
8.5	77-7/8	1978	56-13/16	1443	53-5/16	1354
8.6	86-7/8	2207	65-13/16	1672	62-5/16	1583
8.7	96-7/8	2461	75-13/16	1926	72-5/16	1837
10.3	89	2261	75-1/4	1911	81	2057
10.4	96-1/2	2451	82-3/4	2102	88-1/2	2248
10.5	104	2642	90-1/4	2292	96	2438
12.4	96-3/4	2457	82-1/2	2096	88-5/8	2251
12.5	104-1/4	2648	90	2286	96-1/8	2442
14.4	97-1/8	2467	81-7/8	2080	88-3/4	2254
14.5	104-5/8	2657	89-3/8	2270	96-1/4	2445



**Note:** Circulation heater mounting lug design and location in the assembly drawings shown are standard. Designs can be modified to fit customer installation. Consult Tempco with your requirements.

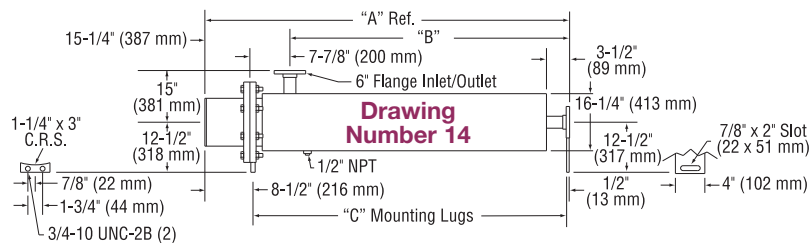
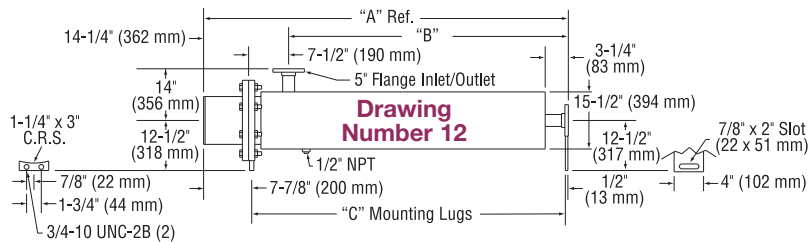
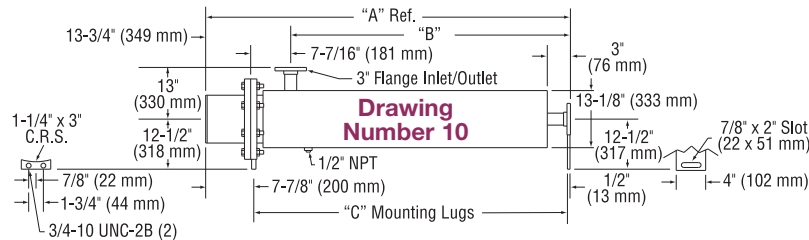

### Ordering Information

See Page 11-69 for complete Ordering Information.





## Circulation Heaters

### Standard (Non-Stock) Circulation Heaters

**23 watts/in<sup>2</sup> (3.6 watts/cm<sup>2</sup>) — Typical Applications: Lightweight Oils • Degreasing Solutions • Heat Transfer Oils**

\* Steel Screw Plug and Steel 150-lb Flanged Heater Sizes

\* Steel Sheath Heating Elements

\* Steel Tank

\* NEMA 1 Terminal Housing

Nominal Pipe Size	Dimensional Drawing Number	KW	Part Number					Approximate Net Weight	
			120V	240V-1Ph (C*)	240V-3Ph (C*)	480V-1Ph (C*)	480V-3Ph (C*)	lbs	kg
1¼" NPT 2 elements	1.1	1.5	CHF01186	CHF01187 (1)	—	—	—	14	6
	1.2	2	CHF01188	CHF01189 (1)	—	—	—	18	8
2½" NPT 3 elements	2.1	3	—	CHF01190 (1)	CHF01191 (1)	CHF01192 (1)	CHF01193 (1)	28	13
	2.1	4.5	—	CHF01194 (1)	CHF01195 (1)	CHF01196 (1)	CHF01197 (1)	29	13
	2.2	6	—	CHF01198 (1)	CHF01199 (1)	CHF01200 (1)	CHF01201 (1)	37	17
	2.3	7.5	—	CHF01202 (1)	CHF01203 (1)	CHF01204 (1)	CHF01205 (1)	45	20
	2.3	9	—	CHF01206 (1)	CHF01207 (1)	CHF01208 (1)	CHF01209 (1)	46	21
3" — 150lb 3 elements	3.1	3	—	CHF01210 (1)	CHF01211 (1)	CHF01212 (1)	CHF01213 (1)	53	24
	3.1	4.5	—	CHF01214 (1)	CHF01215 (1)	CHF01216 (1)	CHF01217 (1)	54	24
	3.2	6	—	CHF01218 (1)	CHF01219 (1)	CHF01220 (1)	CHF01221 (1)	62	28
	3.3	7.5	—	CHF01222 (1)	CHF01223 (1)	CHF01224 (1)	CHF01225 (1)	74	34
	3.3	9	—	CHF01226 (1)	CHF01227 (1)	CHF01228 (1)	CHF01229 (1)	76	34
4" — 150lb 6 elements	4.1	6	—	CHF01230 (1)	CHF01231 (1)	CHF01232 (1)	CHF01233 (1)	78	35
	4.1	9	—	CHF01234 (1)	CHF01235 (1)	CHF01236 (1)	CHF01237 (1)	91	41
	4.2	12	—	CHF01238 (2)	CHF01239 (1)	CHF01240 (1)	CHF01241 (1)	94	43
	4.3	15	—	CHF01242 (2)	CHF01243 (1)	CHF01244 (1)	CHF01245 (1)	117	53
	4.3	18	—	CHF01246 (2)	CHF01247 (1)	CHF01248 (1)	CHF01249 (1)	120	54
	4.4	25	—	—	CHF01250 (2)	CHF01251 (2)	CHF01252 (1)	147	67
	4.4	30	—	—	CHF01253 (2)	CHF01254 (2)	CHF01255 (1)	151	68
5" — 150lb 6 elements	5.2	12	—	CHF01256 (2)	CHF01257 (1)	CHF01258 (1)	CHF01259 (1)	126	57
	5.2	15	—	CHF01260 (2)	CHF01261 (1)	CHF01262 (1)	CHF01263 (1)	128	58
	5.3	18	—	CHF01264 (2)	CHF01265 (1)	CHF01266 (1)	CHF01267 (1)	146	66
	5.3	20	—	CHF01268 (2)	CHF01269 (1)	CHF01270 (1)	CHF01271 (1)	147	67
	5.4	25	—	—	CHF01272 (2)	CHF01273 (2)	CHF01274 (1)	172	78
	5.5	30	—	—	CHF01275 (2)	CHF01276 (2)	CHF01277 (1)	192	87
5" — 150lb 9 elements	5.2	18	—	CHF01278 (3)	CHF01279 (1)	CHF01280 (1)	CHF01281 (1)	132	60
	5.2	23	—	CHF01282 (3)	CHF01283 (3)	CHF01284 (1)	CHF01285 (1)	135	61
	5.3	27	—	CHF01286 (3)	CHF01287 (3)	CHF01288 (3)	CHF01289 (1)	154	70
	5.4	38	—	—	CHF01290 (3)	CHF01291 (3)	CHF01292 (1)	183	83
	5.5	45	—	—	CHF01293 (3)	CHF01294 (3)	CHF01295 (3)	205	93
6" — 150lb 12 elements	6.1	12	—	CHF01296 (1)	CHF01297 (1)	CHF01298 (1)	CHF01299 (1)	127	58
	6.2	18	—	CHF01300 (2)	CHF01301 (1)	CHF01302 (1)	CHF01303 (1)	152	69
	6.2	24	—	CHF01304 (2)	CHF01305 (2)	CHF01306 (1)	CHF01307 (1)	157	71
	6.3	30	—	CHF01308 (2)	CHF01309 (2)	CHF01310 (2)	CHF01311 (1)	197	89
	6.3	36	—	CHF01312 (3)	CHF01313 (2)	CHF01314 (2)	CHF01315 (1)	202	92
	6.4	50	—	—	CHF01316 (4)	CHF01317 (3)	CHF01318 (2)	249	113
	6.4	60	—	—	CHF01319 (4)	CHF01320 (3)	CHF01321 (2)	257	117
6" — 150lb 15 elements	6.1	15	—	CHF01322 (3)	CHF01323 (1)	CHF01324 (1)	CHF01325 (1)	130	59
	6.2	23	—	CHF01326 (3)	CHF01327 (5)	CHF01328 (1)	CHF01329 (1)	156	71
	6.2	30	—	CHF01330 (3)	CHF01331 (5)	CHF01332 (3)	CHF01333 (1)	163	74
	6.3	38	—	CHF01334 (5)	CHF01335 (5)	CHF01336 (3)	CHF01337 (1)	204	93
	6.3	45	—	CHF01338 (5)	CHF01339 (5)	CHF01340 (3)	CHF01341 (5)	211	96
	6.4	63	—	—	CHF01342 (5)	CHF01343 (3)	CHF01344 (5)	260	118
	6.4	75	—	—	CHF01345 (5)	CHF01346 (5)	CHF01347 (5)	270	122
	8.2	30	—	CHF01348 (3)	CHF01349 (2)	CHF01350 (2)	CHF01351 (1)	241	109
	8.3	40	—	—	CHF01352 (2)	CHF01353 (2)	CHF01354 (1)	272	123
	8.4	50	—	—	CHF01355 (3)	CHF01356 (3)	CHF01357 (2)	300	136
8" — 150lb 18 elements	8.5	60	—	—	CHF01358 (3)	CHF01359 (3)	CHF01360 (2)	334	151
	8.6	70	—	—	CHF01361 (6)	CHF01362 (3)	CHF01363 (2)	367	166
	8.7	80	—	—	CHF01364 (6)	—	CHF01365 (2)	402	182
	8.2	40	—	CHF01366 (4)	CHF01367 (2)	CHF01368 (2)	CHF01369 (1)	253	115
	8.3	53	—	—	CHF01370 (4)	CHF01371 (3)	CHF01372 (2)	287	130
8" — 150lb 24 elements	8.4	67	—	—	CHF01373 (4)	CHF01374 (3)	CHF01375 (2)	318	144
	8.5	80	—	—	CHF01376 (4)	CHF01377 (4)	CHF01378 (2)	356	161
	8.6	93	—	—	CHF01379 (8)	CHF01380 (6)	CHF01381 (4)	392	178
	8.7	107	—	—	CHF01382 (8)	—	CHF01383 (4)	428	194

(C\*) = Number of Branch Circuits per heater

**NOTE:** Nominal Pipe Size 8" and larger are 20 watts/in<sup>2</sup> (3.1 watts/cm<sup>2</sup>)

[View Product Inventory @ www.tempco.com](http://www.tempco.com)

### Standard (Non-Stock) Circulation Heaters

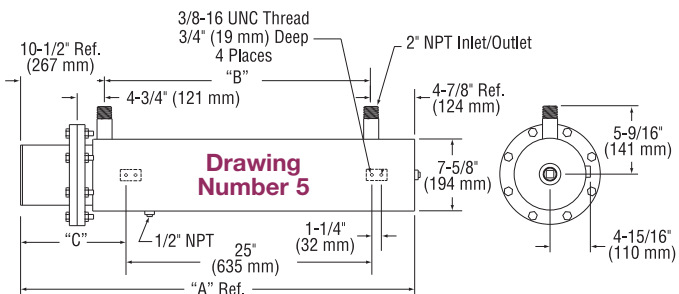
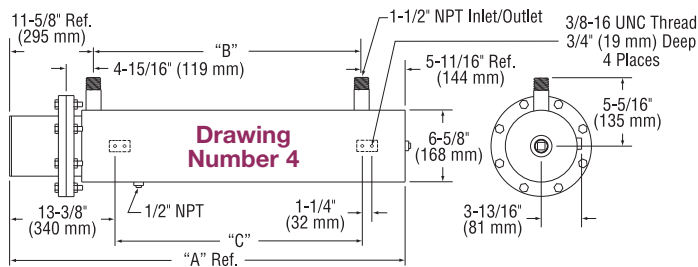
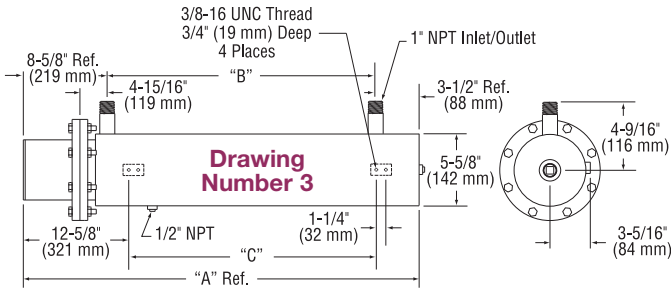
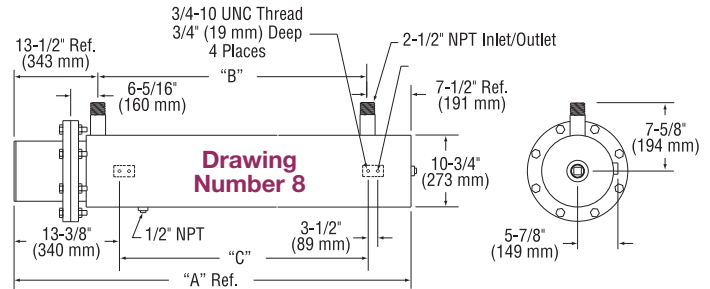
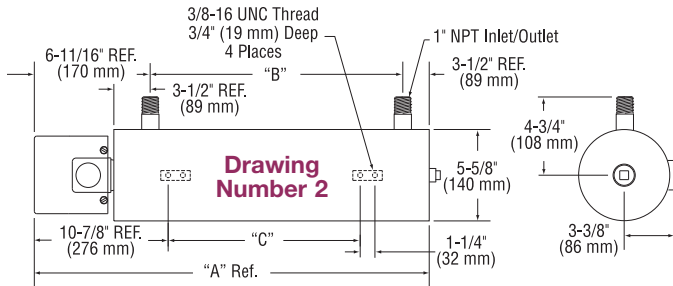
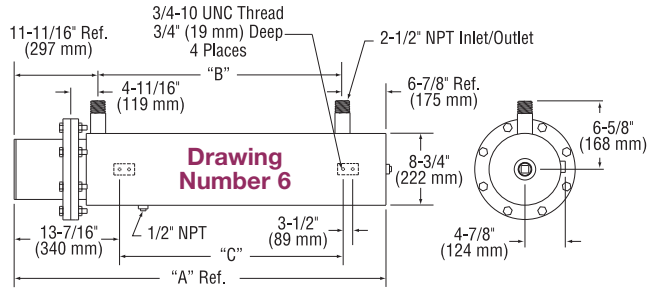
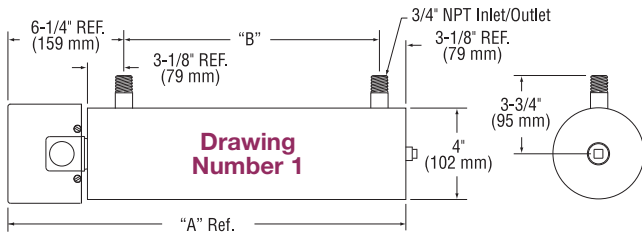

### Dimensional Drawing Number

Drawing Number	"A"		"B"		"C"	
	in	mm	in	mm	in	mm—
1.1	24-3/8	619	15	381	—	—
1.2	32-3/8	822	23	584	—	—
2.1	32-11/16	830	22-1/2	572	16-1/2	419
2.2	42-11/16	1084	32-1/2	826	26-1/2	673
2.3	55-3/16	1402	45	1143	39	991
3.1	34-5/8	879	22-1/2	572	16-1/2	419
3.2	44-5/8	1133	32-1/2	826	26-1/2	673
3.3	57-1/8	1451	45	1143	39	991
4.1	37-13/16	960	20-1/2	521	17	432
4.2	48-5/16	1227	31	787	27-1/2	699
4.3	69-5/16	1761	52	1321	48-1/2	1232
4.4	90-5/16	2294	73	1854	69-1/2	1765
5.2	52-3/8	1330	37	940	15-1/4	387
5.3	63-7/8	1622	48-1/2	1232	21	533
5.4	77-1/4	1962	61-7/8	1572	27-1/2	698
5.5	90-1/4	2292	74-7/8	1902	34-1/4	870
6.1	39-1/16	992	20-1/2	521	17	432
6.2	49-9/16	1259	31	787	27-1/2	699
6.3	70-9/16	1792	52	1321	48-1/2	1232
6.4	91-9/16	2326	73	1854	69-1/2	1765
8.2	53-3/4	1365	32-11/16	830	29-3/16	741
8.3	60-3/4	1543	39-11/16	1008	36-3/16	919
8.4	68-3/4	1746	47-5/16	1202	43-13/16	1113
8.5	77-7/8	1978	56-13/16	1443	53-5/16	1354
8.6	86-7/8	2207	65-13/16	1672	62-5/16	1583
8.7	96-7/8	2461	75-13/16	1926	72-5/16	1837



**Note:** Circulation heater mounting lug design and location in the assembly drawings shown are standard. Designs can be modified to fit customer installation. Consult Tempco with your requirements.

### Ordering Information

See Page 11-69 for complete Ordering Information.



## Circulation Heaters

### Standard (Non-Stock) Circulation Heaters

Continued from previous page...

#### 23 watts/in<sup>2</sup> (3.6 watts/cm<sup>2</sup>) — Typical Applications: Lightweight Oils • Degreasing Solutions • Heat Transfer Oils

- \* Steel Screw Plug and Steel 150-lb Flanged Heater Sizes
- \* Steel Tank

- \* Steel Sheath Heating Elements
- \* NEMA 1 Terminal Housing

Nominal Pipe Size	Dimensional Drawing Number	KW	Part Number				Approximate Net Weight		
			120V	240V-1Ph (C*)	240V-3Ph (C*)	480V-1Ph (C*)	480V-3Ph (C*)	lbs	kgs
10" - 150lb 27 elements	10.3	90	—	—	—	—	CHF01384 (3)	537	244
	10.4	105	—	—	—	—	CHF01385 (3)	580	263
	10.5	120	—	—	—	—	CHF01386 (3)	623	283
12" - 150lb 36 elements	12.4	140	—	—	—	—	CHF01387 (4)	751	341
	12.5	160	—	—	—	—	CHF01388 (4)	793	360
14" - 150lb 45 elements	14.3	150	—	—	—	—	CHF01389 (5)	824	374
	14.4	175	—	—	—	—	CHF01390 (5)	885	401
	14.5	200	—	—	—	—	CHF01391 (5)	941	427

(C\*) = Number of Branch Circuits per heater

**NOTE:** Nominal Pipe Size 8" and larger are 20 watts/in<sup>2</sup> (3.1 watts/cm<sup>2</sup>)



**Note:** Circulation heater mounting lug design and location in the assembly drawings shown are standard. Designs can be modified to fit customer installation.

Consult Tempco with your requirements.

### Dimensional Drawing Number

Drawing Number	"A"		"B"		"C"	
	in	mm	in	mm	in	mm
10.3	89	2261	75-1/4	1911	81	2057
10.4	96-1/2	2451	82-3/4	2102	88-1/2	2248
10.5	104	2642	90-1/4	2292	96	2438
12.4	96-3/4	2457	82-1/2	2096	88-5/8	2251
12.5	104-1/4	2648	90	2286	96-1/8	2442
14.3	89-5/8	2276	74-3/8	1889	81-1/4	2064
14.4	97-1/8	2467	81-7/8	2080	88-3/4	2254
14.5	104-5/8	2657	89-3/8	2270	96-1/4	2445

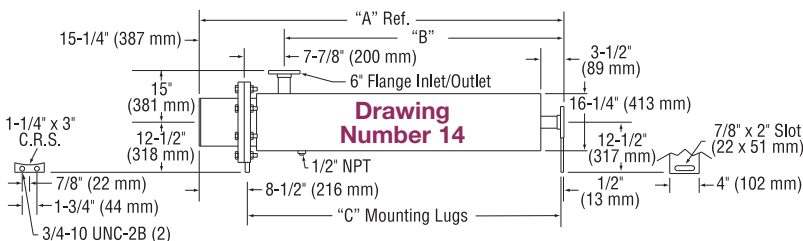
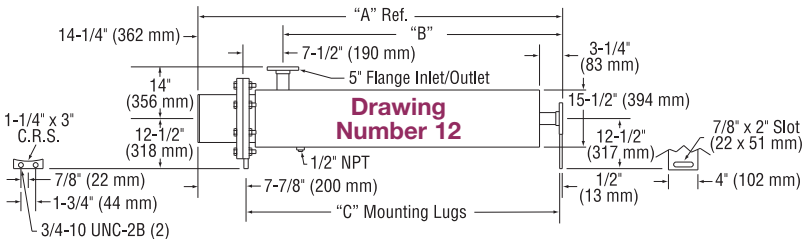
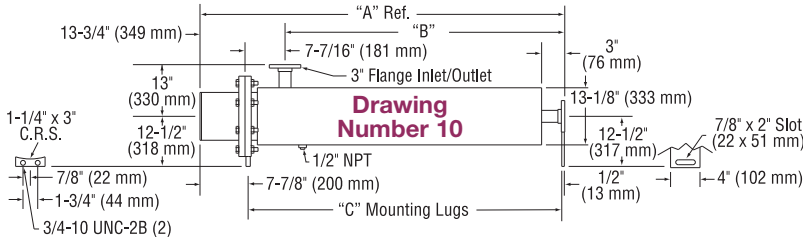

### Ordering Information

See Page 11-69 for complete Ordering Information.

### Standard (Non-Stock) Circulation Heaters

**16 watts/in<sup>2</sup> (2.5 watts/cm<sup>2</sup>) — Typical Applications: Medium Weight Oils • Heat Transfer Oils • Liquid Paraffin**

\* 304 Stainless Steel Screw Plug and Steel 150-lb Flanged Heater Sizes

\* Incoloy®800 Sheath Heating Elements

\* Steel Tank

\* NEMA 1 Terminal Housing

**NOTE: 3-Phase only. Cannot be rewired for single phase.**

Nominal Pipe Size	Dimensional Drawing Number	KW	Part Number					Approximate Net Weight	
			120V	240V-1Ph (C*)	240V-3Ph (C*)	480V-1Ph (C*)	480V-3Ph (C*)	lbs	kgs
2½" NPT 3 elements	2.1	2	—	—	CHF01392 (1)	—	CHF01393 (1)	28	13
	2.1	2.5	—	—	CHF01394 (1)	—	CHF01395 (1)	29	13
	2.1	3	—	—	CHF01396 (1)	—	CHF01397 (1)	30	14
	2.2	4	—	—	CHF01398 (1)	—	CHF01399 (1)	37	17
	2.3	5	—	—	CHF01400 (1)	—	CHF01401 (1)	45	20
	2.3	6	—	—	CHF01402 (1)	—	CHF01403 (1)	46	21
3"-150lb 3 elements	3.1	2	—	—	CHF01404 (1)	—	CHF01405 (1)	53	24
	3.1	2.5	—	—	CHF01406 (1)	—	CHF01407 (1)	53	24
	3.2	3	—	—	CHF01408 (1)	—	CHF01409 (1)	61	28
	3.2	4	—	—	CHF01410 (1)	—	CHF01411 (1)	62	28
	3.3	5	—	—	CHF01412 (1)	—	CHF01413 (1)	74	34
	3.3	6	—	—	CHF01414 (1)	—	CHF01415 (1)	76	34

(C\*) = Number of Branch Circuits per heater

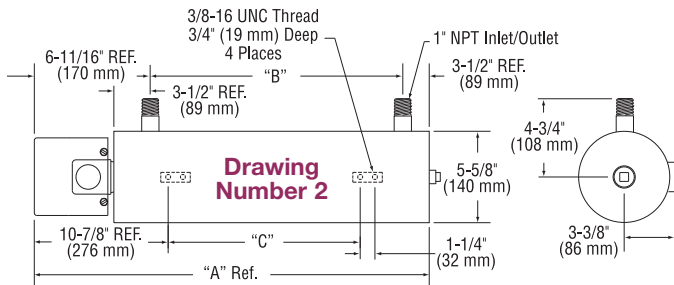

### Dimensional Drawing Number

Drawing Number	"A"		"B"		"C"	
	in	mm	in	mm	in	mm
2.1	32-11/16	830	22-1/2	572	16-1/2	419
2.2	42-11/16	1084	32-1/2	826	26-1/2	673
2.3	55-3/16	1402	45	1143	39	991
3.1	34-5/8	879	22-1/2	572	16-1/2	419
3.2	44-5/8	1133	32-1/2	826	26-1/2	673
3.3	57-1/8	1451	45	1143	39	991

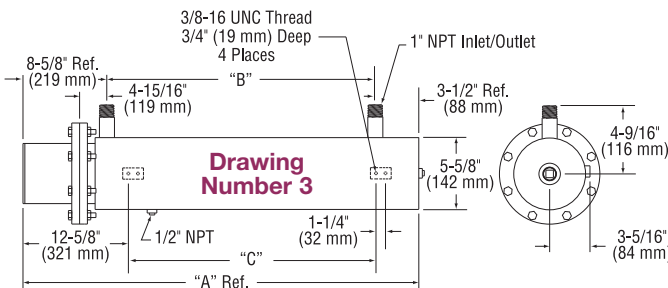

**Note:** Circulation heater mounting lug design and location in the assembly drawings shown are standard. Designs can be modified to fit customer installation. Consult Tempco with your requirements.



**CONTINUED** 

## Circulation Heaters

### Standard (Non-Stock) Circulation Heaters

Continued from previous page...

**16 watts/in<sup>2</sup> (2.5 watts/cm<sup>2</sup>) — Typical Applications: Medium Weight Oils • Heat Transfer Oils • Liquid Paraffin**

**NOTE: 3-Phase only. Cannot be rewired for single phase.**

Nominal Pipe Size	Dimensional Drawing Number	KW	Part Number				Approximate Net Weight		
			120V	240V-1Ph (C*)	240V-3Ph (C*)	480V-1Ph (C*)	480V-3Ph (C*)	lbs	kgs
4"-150lb 6 elements	4.1	3	—	—	CHF01416 (1)	—	CHF01417 (1)	76	34
	4.1	4	—	—	CHF01418 (1)	—	CHF01419 (1)	78	35
	4.1	5	—	—	CHF01420 (1)	—	CHF01421 (1)	79	36
	4.2	6	—	—	CHF01422 (1)	—	CHF01423 (1)	91	41
	4.2	8	—	—	CHF01424 (1)	—	CHF01425 (1)	94	43
	4.3	10	—	—	CHF01426 (1)	—	CHF01427 (1)	117	53
	4.3	12	—	—	CHF01428 (1)	—	CHF01429 (1)	120	54
5"-150lb 6 elements	5.1	8	—	—	CHF01430 (1)	—	CHF01431 (1)	117	53
	5.2	10	—	—	CHF01432 (1)	—	CHF01433 (1)	128	58
	5.3	12	—	—	CHF01434 (1)	—	CHF01435 (1)	146	66
5"-150lb 9 elements	5.1	12	—	—	CHF01436 (1)	—	CHF01437 (1)	123	56
	5.2	15	—	—	CHF01438 (1)	—	CHF01439 (1)	135	61
	5.3	18	—	—	CHF01440 (1)	—	CHF01441 (1)	154	70
6"-150lb 12 elements	6.1	6	—	—	CHF01442 (1)	—	CHF01443 (1)	124	56
	6.1	8	—	—	CHF01444 (1)	—	CHF01445 (1)	127	58
	6.1	10	—	—	CHF01446 (1)	—	CHF01447 (1)	129	59
	6.2	12	—	—	CHF01448 (1)	—	CHF01449 (1)	152	69
	6.2	16	—	—	CHF01450 (1)	—	CHF01451 (1)	157	71
	6.3	20	—	—	CHF01452 (1)	—	CHF01453 (1)	197	89
	6.3	24	—	—	CHF01454 (2)	—	CHF01455 (1)	202	92
6"-150lb 15 elements	6.1	7.5	—	—	CHF01456 (1)	—	CHF01457 (1)	126	57
	6.1	10	—	—	CHF01458 (1)	—	CHF01459 (1)	130	59
	6.1	12.5	—	—	CHF01460 (1)	—	CHF01461 (1)	133	60
	6.2	15	—	—	CHF01462 (1)	—	CHF01463 (1)	156	71
	6.2	20	—	—	CHF01464 (1)	—	CHF01465 (1)	163	74
	6.3	25	—	—	CHF01466 (5)	—	CHF01467 (1)	164	74
	6.3	30	—	—	CHF01468 (5)	—	CHF01469 (1)	211	96
8"-150lb 18 elements	8.2	17	—	—	CHF01470 (1)	—	CHF01471 (1)	234	106
	8.3	25	—	—	CHF01472 (2)	—	CHF01473 (1)	264	120
	8.4	33	—	—	CHF01474 (2)	—	CHF01475 (1)	293	133
	8.5	42	—	—	CHF01476 (3)	—	CHF01477 (2)	327	148
	8.6	50	—	—	—	—	CHF01478 (2)	360	163
	8.7	58	—	—	—	—	CHF01479 (2)	395	179
	8.7	67	—	—	—	—	CHF01480 (2)	405	184
8"-150lb 24 elements	8.2	23	—	—	CHF01481 (2)	—	CHF01482 (1)	243	110
	8.3	33	—	—	CHF01483 (2)	—	CHF01484 (1)	277	126
	8.4	44	—	—	CHF01485 (4)	—	CHF01486 (2)	308	140
	8.5	56	—	—	CHF01487 (4)	—	CHF01488 (2)	346	157
	8.6	67	—	—	—	—	CHF01489 (2)	382	173
	8.7	77	—	—	—	—	CHF01490 (2)	420	191
	8.7	89	—	—	—	—	CHF01491 (4)	433	196
10"-150lb 27 elements	10.3	75	—	—	—	—	CHF01492 (3)	539	244
	10.5	87	—	—	—	—	CHF01493 (3)	615	279
12"-150lb 36 elements	12.3	100	—	—	—	—	CHF01494 (3)	694	315
	12.5	117	—	—	—	—	CHF01495 (3)	782	355
14"-150lb 45 elements	14.2	105	—	—	—	—	CHF01496 (3)	771	350
	14.3	125	—	—	—	—	CHF01497 (5)	828	376

(C\*) = Number of Branch Circuits per heater

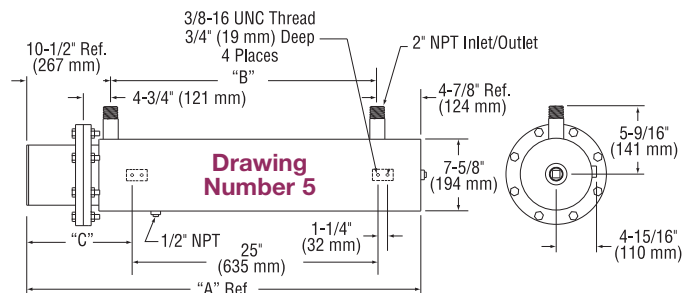
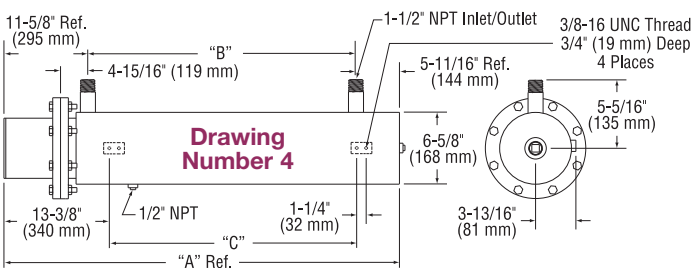

View Product Inventory @ [www.tempco.com](http://www.tempco.com)



### Standard (Non-Stock) Circulation Heaters

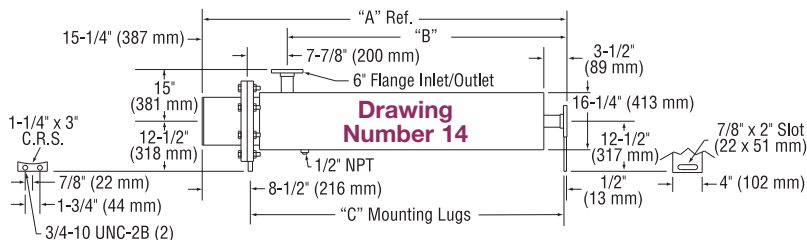
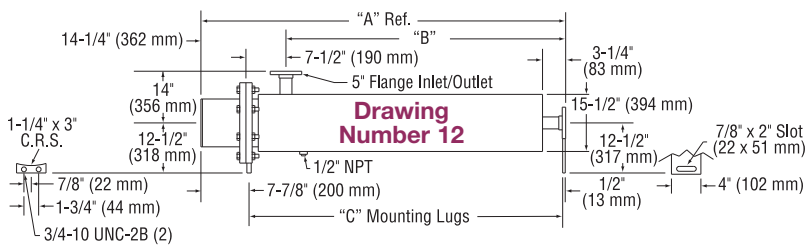
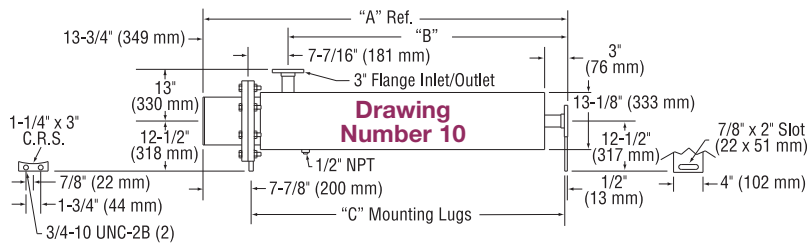
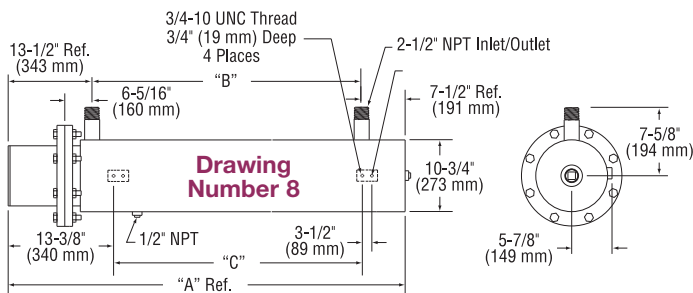
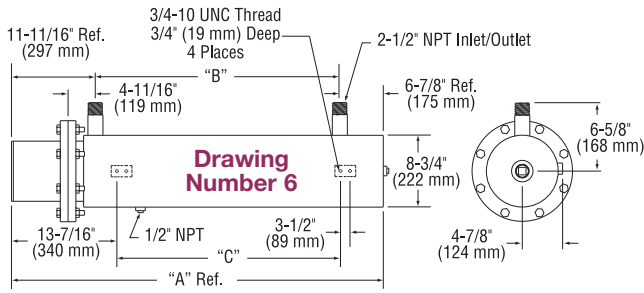

### Dimensional Drawing Number

Drawing Number	"A"		"B"		"C"	
	in	mm	in	mm	in	mm
4.1	37-13/16	960	20-1/2	521	17	432
4.2	48-5/16	1227	31	787	27-1/2	699
4.3	69-5/16	1761	52	1321	48-1/2	1232
5.1	45-3/8	1153	30	762	11-1/2	292
5.2	52-3/8	1330	37	940	15-1/4	387
5.3	63-7/8	1622	48-1/2	1232	21	533
6.1	39-1/16	992	20-1/2	521	17	432
6.2	49-9/16	1259	31	787	27-1/2	699
6.3	70-9/16	1792	52	1321	48-1/2	1232
8.2	53-3/4	1365	32-11/16	830	29-3/16	741
8.3	60-3/4	1543	39-11/16	1008	36-3/16	919
8.4	68-3/4	1746	47-5/16	1202	43-13/16	1113
8.5	77-7/8	1978	56-13/16	1443	53-5/16	1354
8.6	86-7/8	2207	65-13/16	1672	62-5/16	1583
8.7	96-7/8	2461	75-13/16	1926	72-5/16	1837
10.3	89	2261	75-1/4	1911	81	2057
10.5	104	2642	90-1/4	2292	96	2438
12.3	89-1/4	2267	75	1905	81-1/8	2061
12.5	104-1/4	2648	90	2286	96-1/8	2442
14.2	82-1/8	2086	66-7/8	1699	73-3/4	1873
14.3	89-5/8	2276	74-3/8	1889	81-1/4	2064



**Note:** Circulation heater mounting lug design and location in the assembly drawings shown are standard. Designs can be modified to fit customer installation.

Consult Tempco with your requirements.



Circulation heater with optional externally mounted thermostat.

### Ordering Information

See Page 11-69 for complete Ordering Information.



## Circulation Heaters

### Standard (Non-Stock) Circulation Heaters

**23 watts/in<sup>2</sup> (3.6 watts/cm<sup>2</sup>) — Typical Applications: Forced Air & Gases • Caustic Solutions • Degreasing Solutions**

\* 304 Stainless Steel Screw Plug and Steel 150-lb Flanged Heater Sizes

\* Incoloy® 800 Sheath Heating Elements

\* Steel Tank

\* NEMA 1 Terminal Housing

Nominal Pipe Size	Dimensional Drawing Number	KW	Part Number					Approximate Net Weight	
			120V	240V-1Ph (C*)	240V-3Ph (C*)	480V-1Ph (C*)	480V-3Ph (C*)	lbs	kgs
1½" NPT 2 elements	1.1	1	CHF01498	CHF01499 (1)	—	—	—	13	6
	1.1	1.5	CHF01500	CHF01501 (1)	—	—	—	13	6
	1.2	2	CHF01502	CHF01503 (1)	—	—	—	17	8
2½" NPT 3 elements	2.1	3	—	CHF01504 (1)	CHF01505 (1)	CHF01506 (1)	CHF01507 (1)	28	13
	2.2	4.5	—	CHF01508 (1)	CHF01509 (1)	CHF01510 (1)	CHF01511 (1)	35	16
	2.2	6	—	CHF01512 (1)	CHF01513 (1)	CHF01514 (1)	CHF01515 (1)	37	17
	2.3	7.5	—	CHF01516 (1)	CHF01517 (1)	CHF01518 (1)	CHF01519 (1)	45	20
	2.3	9	—	CHF01520 (1)	CHF01521 (1)	CHF01522 (1)	CHF01523 (1)	46	21
3"-150lb 3 elements	3.1	3	—	CHF01524 (1)	CHF01525 (1)	CHF01526 (1)	CHF01527 (1)	53	24
	3.2	4.5	—	CHF01528 (1)	CHF01529 (1)	CHF01530 (1)	CHF01531 (1)	61	28
	3.2	6	—	CHF01532 (1)	CHF01533 (1)	CHF01534 (1)	CHF01535 (1)	62	28
	3.3	7.5	—	CHF01536 (1)	CHF01537 (1)	CHF01538 (1)	CHF01539 (1)	74	34
	3.3	9	—	CHF01540 (1)	CHF01541 (1)	CHF01542 (1)	CHF01543 (1)	76	34
4"-150lb 6 elements	4.1	6	—	CHF01544 (1)	CHF01545 (1)	CHF01546 (1)	CHF01547 (1)	78	35
	4.2	9	—	CHF01548 (1)	CHF01549 (1)	CHF01550 (1)	CHF01551 (1)	91	41
	4.2	12	—	CHF01552 (2)	CHF01553 (1)	CHF01554 (1)	CHF01555 (1)	94	43
	4.3	15	—	CHF01556 (2)	CHF01557 (1)	CHF01558 (1)	CHF01559 (1)	117	53
	4.3	18	—	CHF01560 (2)	CHF01561 (1)	CHF01562 (1)	CHF01563 (1)	120	54
	4.4	25	—	—	CHF01564 (2)	CHF01565 (2)	CHF01566 (1)	147	67
5"-150lb 6 elements	4.4	30	—	—	CHF01567 (2)	CHF01568 (2)	CHF01569 (1)	151	68
	5.1	9	—	CHF01570 (1)	CHF01571 (1)	CHF01572 (1)	CHF01573 (1)	114	52
	5.2	12	—	CHF01574 (2)	CHF01575 (1)	CHF01576 (1)	CHF01577 (1)	126	57
	5.2	15	—	CHF01578 (2)	CHF01579 (1)	CHF01580 (1)	CHF01581 (1)	128	58
	5.3	18	—	CHF01582 (2)	CHF01583 (1)	CHF01584 (1)	CHF01585 (1)	146	66
	5.4	25	—	—	CHF01586 (2)	CHF01587 (2)	CHF01588 (1)	172	78
5"-150lb 9 elements	5.5	30	—	—	CHF01589 (2)	CHF01590 (2)	CHF01591 (1)	192	87
	5.1	14	—	CHF01592 (3)	CHF01593 (1)	CHF01594 (1)	CHF01595 (1)	119	54
	5.2	18	—	CHF01596 (3)	CHF01597 (1)	CHF01598 (1)	CHF01599 (1)	132	60
	5.2	23	—	CHF01600 (3)	CHF01601 (3)	CHF01602 (1)	CHF01603 (1)	135	61
	5.3	27	—	CHF01604 (3)	CHF01605 (3)	CHF01606 (3)	CHF01607 (1)	150	68
	5.4	38	—	—	CHF01608 (3)	CHF01609 (3)	CHF01610 (1)	183	83
6"-150lb 12 elements	5.5	45	—	—	CHF01611 (3)	CHF01612 (3)	CHF01613 (3)	205	93
	6.1	12	—	CHF01614 (2)	CHF01615 (1)	CHF01616 (1)	CHF01617 (1)	127	58
	6.2	18	—	CHF01618 (2)	CHF01619 (1)	CHF01620 (1)	CHF01621 (1)	152	69
	6.2	24	—	CHF01622 (2)	CHF01623 (2)	CHF01624 (2)	CHF01625 (1)	157	71
	6.3	30	—	CHF01626 (3)	CHF01627 (2)	CHF01628 (2)	CHF01629 (1)	197	89
	6.3	36	—	CHF01630 (3)	CHF01631 (2)	CHF01632 (2)	CHF01633 (1)	202	92
	6.4	50	—	—	CHF01634 (4)	CHF01635 (4)	CHF01636 (2)	249	113
6.4	60	—	—	CHF01637 (4)	CHF01638 (4)	CHF01639 (2)	257	117	
6"-150lb 15 elements	6.1	15	—	CHF01640 (3)	CHF01641 (1)	CHF01642 (1)	CHF01643 (1)	130	59
	6.2	23	—	CHF01644 (3)	CHF01645 (5)	CHF01646 (1)	CHF01647 (1)	156	71
	6.2	30	—	CHF01648 (3)	CHF01649 (5)	CHF01650 (3)	CHF01651 (1)	163	74
	6.3	38	—	CHF01652 (5)	CHF01653 (5)	CHF01654 (3)	CHF01655 (1)	204	93
	6.3	45	—	CHF01656 (5)	CHF01657 (5)	CHF01658 (3)	CHF01659 (5)	211	96
	6.4	63	—	—	CHF01660 (5)	CHF01661 (3)	CHF01662 (5)	260	118
	6.4	75	—	—	CHF01663 (5)	CHF01664 (5)	CHF01665 (5)	270	122
8"-150lb 18 elements	8.2	30	—	CHF01666 (3)	CHF01667 (2)	CHF01668 (2)	CHF01669 (1)	244	111
	8.3	40	—	—	CHF01670 (2)	CHF01671 (2)	CHF01672 (1)	274	124
	8.4	50	—	—	CHF01673 (3)	CHF01674 (3)	CHF01675 (2)	303	137
8"-150lb 24 elements	8.2	40	—	CHF01676 (4)	CHF01677 (2)	CHF01678 (2)	CHF01679 (1)	253	115
	8.3	53	—	—	CHF01680 (4)	CHF01681 (3)	CHF01682 (2)	287	130
	8.4	67	—	—	CHF01683 (4)	CHF01684 (3)	CHF01685 (2)	318	144

(C\*) = Number of Branch Circuits per heater

**NOTE:** Nominal Pipe Size 8" and larger are 20 watts/in<sup>2</sup> (3.1 watts/cm<sup>2</sup>)

### Standard (Non-Stock) Circulation Heaters

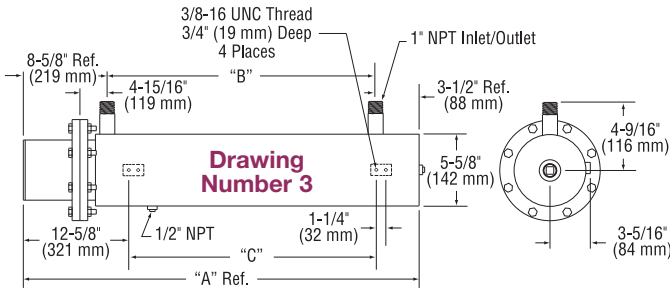
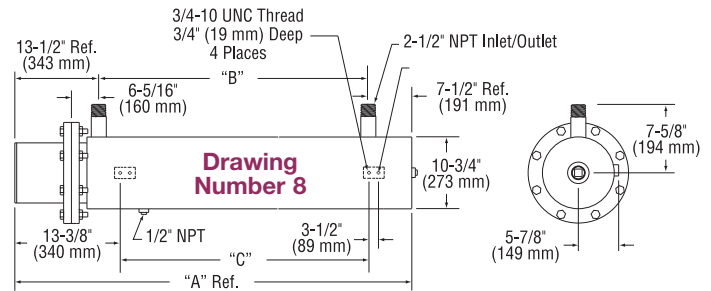
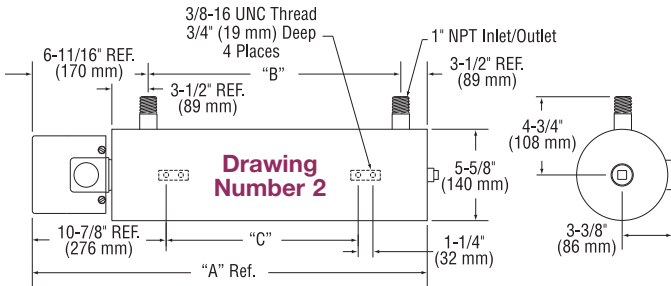
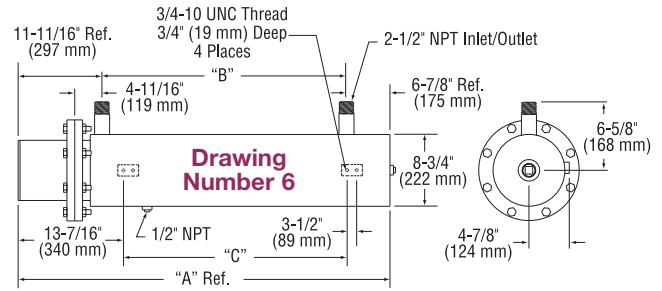
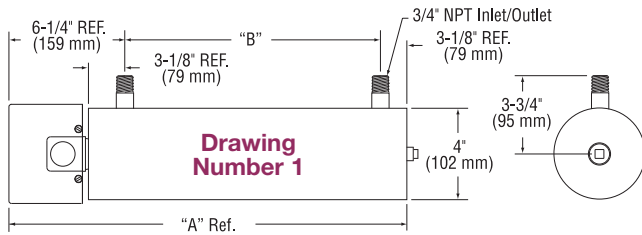

### Dimensional Drawing Number

Drawing Number	"A"		"B"		"C"	
	in	mm	in	mm	in	mm
1.1	24-3/8	619	15	381		
1.2	32-3/8	822	23	584		
2.1	32-11/16	830	22-1/2	572	16-1/2	419
2.2	42-11/16	1084	32-1/2	826	26-1/2	673
2.3	55-3/16	1402	45	1143	39	991
3.1	34-5/8	879	22-1/2	572	16-1/2	419
3.2	44-5/8	1133	32-1/2	826	26-1/2	673
3.3	57-1/8	1451	45	1143	39	991
4.1	37-13/16	960	20-1/2	521	17	432
4.2	48-5/16	1227	31	787	27-1/2	699
4.3	69-5/16	1761	52	1321	48-1/2	1232
4.4	90-5/16	2294	73	1854	69-1/2	1765
5.1	45-3/8	1153	30	762	11-1/2	292
5.2	52-3/8	1330	37	940	15-1/4	387
5.3	63-7/8	1622	48-1/2	1232	21	533
5.4	77-1/4	1962	61-7/8	1572	27-1/2	698
5.5	90-1/4	2292	74-7/8	1902	34-1/4	870
6.1	39-1/16	992	20-1/2	521	17	432
6.2	49-9/16	1259	31	787	27-1/2	699
6.3	70-9/16	1792	52	1321	48-1/2	1232
6.4	91-9/16	2326	73	1854	69-1/2	1765
8.2	53-3/4	1365	32-11/16	830	29-3/16	741
8.3	60-3/4	1543	39-11/16	1008	36-3/16	919
8.4	68-3/4	1746	47-5/16	1202	43-13/16	1113

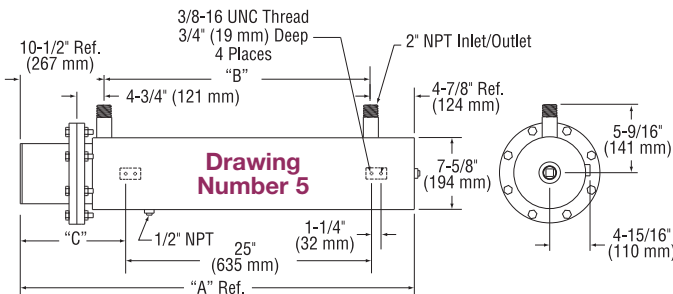
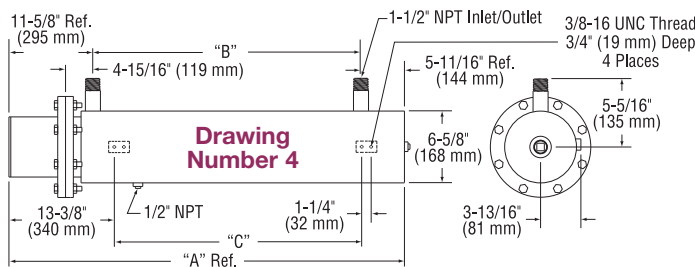

**Note:** Circulation heater mounting lug design and location in the assembly drawings shown are standard. Designs can be modified to fit customer installation. Consult Tempco with your requirements.

### Ordering Information

See Page 11-69 for complete Ordering Information.

**CONTINUED**

## Circulation Heaters

### Standard (Non-Stock) Circulation Heaters

Continued from previous page...

### 23 watts/in<sup>2</sup> (3.6 watts/cm<sup>2</sup>) — Typical Applications: Forced Air & Gases • Caustic Solutions • Degreasing Solutions

Nominal Pipe Size	Dimensional Drawing Number	KW	Part Number				Approximate Net Weight		
			120V	240V-1Ph (C*)	240V-3Ph (C*)	480V-1Ph (C*)	480V-3Ph (C*)	lbs	kgs
10"-150lb 27 elements	10.1	60	—	—	CHF01686 (3)	—	CHF01687 (3)	440	200
	10.2	75	—	—	CHF01688 (9)	—	CHF01689 (3)	485	220
12"-150lb 36 elements	12.1	80	—	—	—	—	CHF01690 (3)	550	250
	12.2	100	—	—	—	—	CHF01691 (3)	595	270
14"-150lb 45 elements	14.1	100	—	—	—	—	CHF01692 (3)	675	307
	14.2	125	—	—	—	—	CHF01693 (5)	771	350

(C\*) = Number of Branch Circuits per heater

**NOTE:** Nominal Pipe Size 8" and larger are 20 watts/in<sup>2</sup> (3.1 watts/cm<sup>2</sup>)

### Dimensional Drawing Number

Drawing Number	"A"		"B"		"C"	
	in	mm	in	mm	in	mm
10.1	74	1880	60-1/4	1531	66	1676
10.2	81-1/2	2070	67-3/4	1721	73-1/2	1867
12.1	74-1/4	1886	60	1524	66-1/8	1680
12.2	81-3/4	2076	67-1/2	1715	73-5/8	1870
14.1	74-5/8	1895	59-3/8	1508	66-1/4	1683
14.2	82-1/8	2086	66-7/8	1699	73-3/4	1873



**Note:** Circulation heater mounting lug design and location in the assembly drawings shown are standard. Designs can be modified to fit customer installation. Consult Tempco with your requirements.

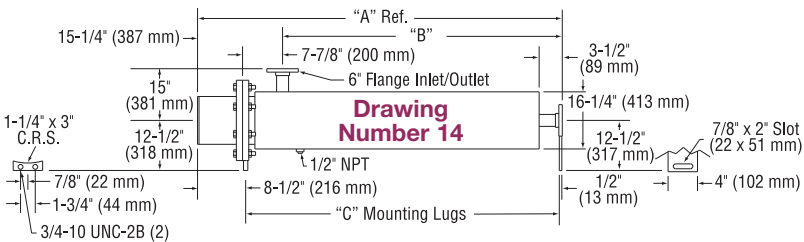
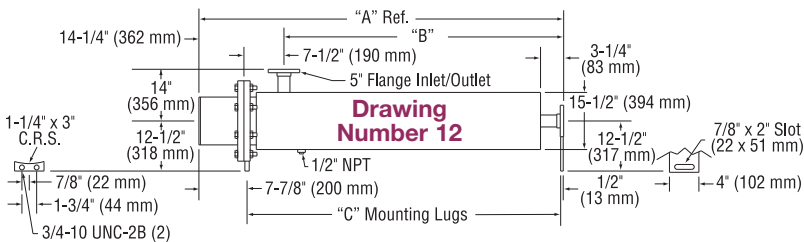
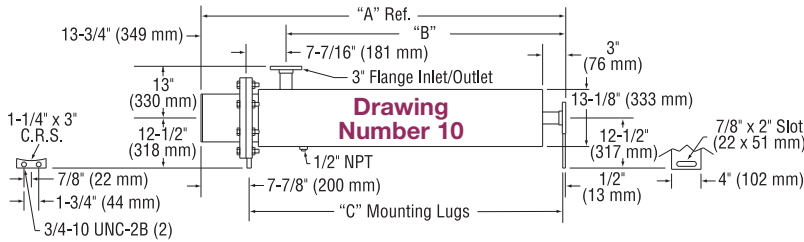

### Ordering Information

See Page 11-69 for complete Ordering Information.



### Standard (Non-Stock) Circulation Heaters

**48 watts/in<sup>2</sup> (7.5 watts/cm<sup>2</sup>) — Typical Applications: Process Water**

- \* 304 Stainless Steel Screw Plug and Steel 150-lb Flanged Heater Sizes
- \* Steel Tank

- \* Incoloy®800 Sheath Heating Elements
- \* NEMA 1 Terminal Housing

Nominal Pipe Size	Dimensional Drawing Number	KW	Part Number					Approximate Net Weight	
			120V	240V-1Ph (C*)	240V-3Ph (C*)	480V-1Ph (C*)	480V-3Ph (C*)	lbs	kgs
2½" NPT 3 elements	2.1	6	—	CHF01694 (1)	CHF01695 (1)	CHF01696 (1)	CHF01697 (1)	28	13
	2.1	7.5	—	CHF01698 (1)	CHF01699 (1)	CHF01700 (1)	CHF01701 (1)	29	13
	2.1	9	—	CHF01702 (1)	CHF01703 (1)	CHF01704 (1)	CHF01705 (1)	30	14
	2.2	12	—	—	CHF01706 (1)	CHF01707 (1)	CHF01708 (1)	37	17
	2.3	15	—	—	CHF01709 (1)	CHF01710 (1)	CHF01711 (1)	45	20
	2.3	18	—	—	CHF01712 (1)	CHF01713 (1)	CHF01714 (1)	46	21
3"-150lb 3 elements	3.1	6	—	CHF01715 (1)	CHF01716 (1)	CHF01717 (1)	CHF01718 (1)	53	24
	3.1	7.5	—	CHF01719 (1)	CHF01720 (1)	CHF01721 (1)	CHF01722 (1)	53	24
	3.2	9	—	CHF01723 (1)	CHF01724 (1)	CHF01725 (1)	CHF01726 (1)	61	28
	3.2	12	—	—	CHF01727 (1)	CHF01728 (1)	CHF01729 (1)	62	28
	3.3	15	—	—	CHF01730 (1)	CHF01731 (1)	CHF01732 (1)	74	34
	3.3	18	—	—	CHF01733 (1)	CHF01734 (1)	CHF01735 (1)	76	34

(C\*) = Number of Branch Circuits per heater

### Dimensional Drawing Number

Drawing Number	"A"		"B"		"C"	
	in	mm	in	mm	in	mm
2.1	32-11/16	830	22-1/2	572	16-1/2	419
2.2	42-11/16	1084	32-1/2	826	26-1/2	673
2.3	55-3/16	1402	45	1143	39	991
3.1	34-5/8	879	22-1/2	572	16-1/2	419
3.2	44-5/8	1133	32-1/2	826	26-1/2	673
3.3	57-1/8	1451	45	1143	39	991



**Note:** Circulation heater mounting lug design and location in the assembly drawings shown are standard. Designs can be modified to fit customer installation. Consult Tempco with your requirements.

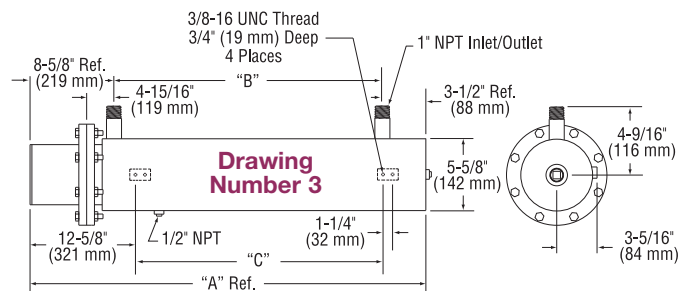
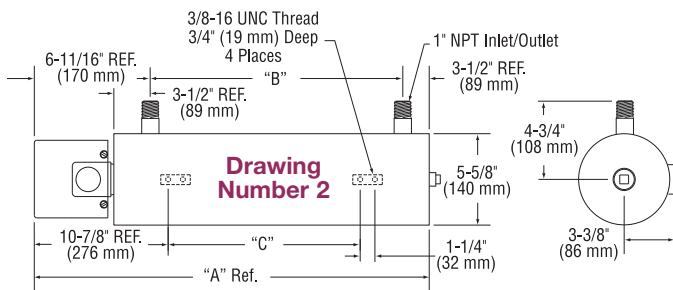

Circulation heater with optional externally mounted thermostat.

### Ordering Information

See Page 11-69 for complete Ordering Information.

**CONTINUED** →



### Standard (Non-Stock) Circulation Heaters

Continued from previous page...

**48 watts/in<sup>2</sup> (7.5 watts/cm<sup>2</sup>) — Typical Applications: Process Water**

Nominal Pipe Size	Dimensional Drawing Number	KW	Part Number					Approximate Net Weight	
			120V	240V-1Ph (C*)	240V-3Ph (C*)	480V-1Ph (C*)	480V-3Ph (C*)	lbs	kgs
4"-150lb 6 elements	4.1	9	—	CHF01736 (1)	CHF01737 (1)	CHF01738 (1)	CHF01739 (1)	76	34
	4.1	12	—	CHF01740 (2)	CHF01741 (1)	CHF01742 (1)	CHF01743 (1)	78	35
	4.1	15	—	CHF01744 (2)	CHF01745 (1)	CHF01746 (1)	CHF01747 (1)	79	36
	4.2	18	—	CHF01748 (2)	CHF01749 (1)	CHF01750 (1)	CHF01751 (1)	91	41
	4.2	24	—	CHF01752 (2)	CHF01753 (2)	CHF01754 (2)	CHF01755 (1)	94	43
	4.3	30	—	—	CHF01756 (2)	CHF01757 (2)	CHF01758 (1)	117	53
5"-150lb 6 elements	4.3	36	—	—	CHF01759 (2)	CHF01760 (2)	CHF01761 (1)	120	54
	5.1	24	—	CHF01762 (2)	CHF01763 (2)	CHF01764 (2)	CHF01765 (1)	117	53
	5.2	30	—	—	CHF01766 (2)	CHF01767 (2)	CHF01768 (1)	128	58
5"-150lb 9 elements	5.3	36	—	—	CHF01769 (2)	CHF01770 (2)	CHF01771 (1)	146	66
	5.1	36	—	—	CHF01772 (3)	CHF01773 (3)	CHF01774 (1)	123	56
	5.2	45	—	—	CHF01775 (3)	CHF01776 (3)	CHF01777 (3)	135	61
6"-150lb 12 elements	5.3	54	—	—	CHF01778 (3)	CHF01779 (3)	CHF01780 (3)	154	70
	6.1	18	—	CHF01781 (2)	CHF01782 (1)	CHF01783 (1)	CHF01784 (1)	124	56
	6.1	24	—	CHF01785 (2)	CHF01786 (2)	CHF01787 (2)	CHF01788 (1)	127	58
	6.1	30	—	CHF01789 (3)	CHF01790 (2)	CHF01791 (2)	CHF01792 (1)	129	59
	6.2	36	—	CHF01793 (3)	CHF01794 (2)	CHF01795 (2)	CHF01796 (1)	152	69
	6.2	48	—	—	CHF01797 (4)	CHF01798 (3)	CHF01799 (2)	157	71
	6.3	60	—	—	CHF01800 (4)	CHF01801 (3)	CHF01802 (2)	197	89
6"-150lb 15 elements	6.3	72	—	—	CHF01803 (4)	—	CHF01804 (2)	202	92
	6.1	23	—	CHF01805 (3)	CHF01806 (5)	CHF01807 (1)	CHF01808 (1)	126	57
	6.1	30	—	CHF01809 (3)	CHF01810 (5)	CHF01811 (3)	CHF01812 (1)	130	59
	6.1	38	—	CHF01813 (5)	CHF01814 (5)	CHF01815 (3)	CHF01816 (1)	132	60
	6.2	45	—	CHF01817 (5)	CHF01818 (5)	CHF01819 (3)	CHF01820 (5)	156	71
	6.2	60	—	—	CHF01821 (5)	CHF01822 (3)	CHF01823 (5)	163	74
	6.3	75	—	—	CHF01824 (5)	CHF01825 (5)	CHF01826 (5)	204	93
8"-150lb 18 elements	6.3	90	—	—	CHF01827 (5)	—	CHF01828 (5)	211	96
	8.2	50	—	—	CHF01829 (3)	CHF01830 (3)	CHF01831 (2)	234	106
	8.3	75	—	—	CHF01832 (6)	—	CHF01833 (2)	264	120
	8.4	100	—	—	CHF01834 (6)	—	CHF01835 (3)	293	133
	8.5	125	—	—	CHF01836 (6)	—	CHF01837 (6)	327	148
	8.6	150	—	—	—	—	CHF01838 (6)	360	163
	8.7	175	—	—	—	—	CHF01839 (6)	395	179
8"-150lb 24 elements	8.7	200	—	—	—	—	CHF01840 (6)	405	184
	8.2	67	—	—	CHF01841 (4)	CHF01842 (3)	CHF01843 (2)	243	110
	8.3	100	—	—	CHF01844 (8)	—	CHF01845 (4)	277	126
	8.4	133	—	—	CHF01846 (8)	—	CHF01847 (4)	308	140
	8.5	167	—	—	CHF01848 (8)	—	CHF01849 (8)	346	157
	8.6	200	—	—	—	—	CHF01850 (8)	382	173
	8.7	233	—	—	—	—	CHF01851 (8)	420	191
10"-150lb 27 elements	8.7	267	—	—	—	—	CHF01852 (8)	433	196
	10.3	225	—	—	—	—	CHF01853 (9)	539	244
12"-150lb 36 elements	10.5	262	—	—	—	—	CHF01854 (9)	615	279
	12.3	300	—	—	—	—	CHF01855 (12)	694	315
14"-150lb 45 elements	12.5	350	—	—	—	—	CHF01856 (12)	782	355
	14.2	315	—	—	—	—	CHF01857 (15)	771	350
	14.3	375	—	—	—	—	CHF01858 (15)	827	375

(C\*) = Number of Branch Circuits per heater

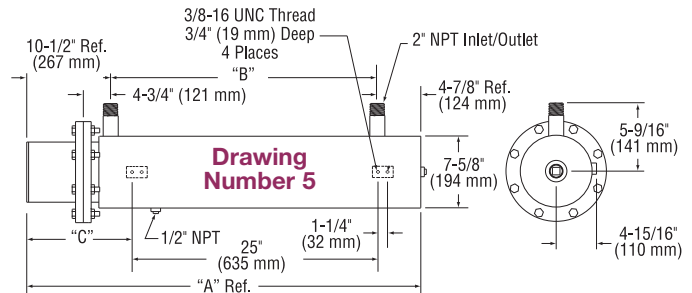
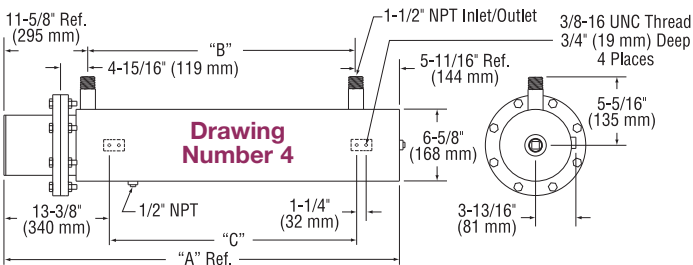

### Standard (Non-Stock) Circulation Heaters

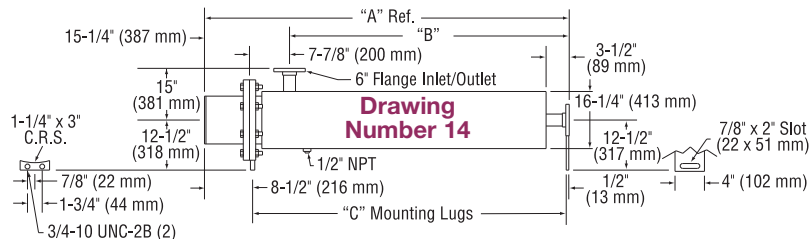
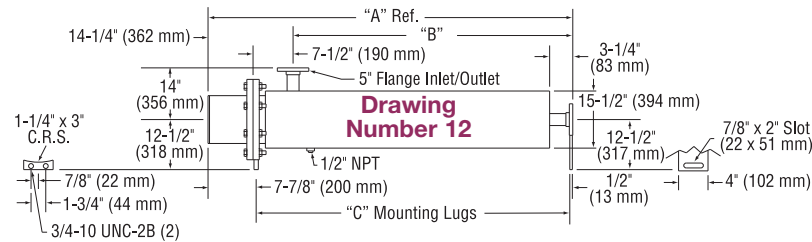
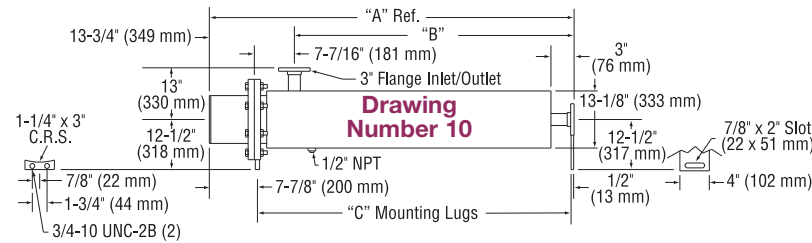
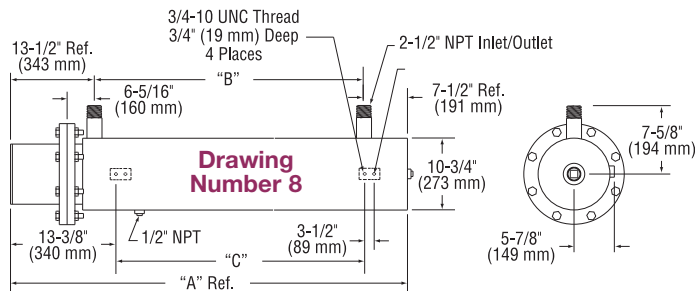
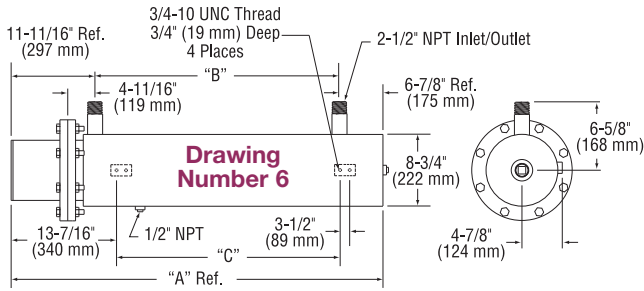

### Dimensional Drawing Number

Drawing Number	"A"		"B"		"C"	
	in	mm	in	mm	in	mm
4.1	37-13/16	960	20-1/2	521	17	432
4.2	48-5/16	1227	31	787	27-1/2	699
4.3	69-5/16	1761	52	1321	48-1/2	1232
5.1	45-3/8	1153	30	762	11-1/2	292
5.2	52-3/8	1330	37	940	15-1/4	387
5.3	63-7/8	1622	48-1/2	1232	21	533
6.1	39-1/16	992	20-1/2	521	17	432
6.2	49-9/16	1259	31	787	27-1/2	699
6.3	70-9/16	1792	52	1321	48-1/2	1232
8.2	53-3/4	1365	32-11/16	830	29-3/16	741
8.3	60-3/4	1543	39-11/16	1008	36-3/16	919
8.4	68-3/4	1746	47-5/16	1202	43-13/16	1113
8.5	77-7/8	1978	56-13/16	1443	53-5/16	1354
8.6	86-7/8	2207	65-13/16	1672	62-5/16	1583
8.7	96-7/8	2461	75-13/16	1926	72-5/16	1837
10.3	89	2261	75-1/4	1911	81	2057
10.5	104	2642	90-1/4	2292	96	2438
12.3	89-1/4	2267	75	1905	81-1/8	2061
12.5	104-1/4	2648	90	2286	96-1/8	2442
14.2	82-1/8	2086	66-7/8	1699	73-3/4	1873
14.3	89-5/8	2276	74-3/8	1889	81-1/4	2064



**Note:** Circulation heater mounting lug design and location in the assembly drawings shown are standard. Designs can be modified to fit customer installation. Consult Tempco with your requirements.

### Ordering Information

See Page 11-69 for complete Ordering Information.



## Circulation Heaters

### Standard (Non-Stock) Circulation Heaters

60 watts/in<sup>2</sup> (9.3 watts/cm<sup>2</sup>) — Typical Applications: Clean Water

- \* Brass Screw Plug and Steel 150-lb Flanged Heater Sizes
- \* Steel Tank

- \* Copper Sheath Heating Elements
- \* NEMA 1 Terminal Housing

Nominal Pipe Size	Dimensional Drawing Number	KW	Part Number					Approximate Net Weight	
			120V	240V-1Ph (C*)	240V-3Ph (C*)	480V-1Ph (C*)	480V-3Ph (C*)	lbs	kg
1¼" NPT 2 elements	1.1	3	CHF01859	CHF01860 (1)	—	—	—	14	6
	1.1	4	—	CHF01861 (1)	—	—	—	14	6
	1.2	5	—	CHF01862 (1)	—	—	—	17	8
	1.2	6	—	CHF01863 (1)	—	—	—	18	8
2½" NPT 3 elements	2.1	6	—	CHF01864 (1)	CHF01865 (1)	CHF01866 (1)	CHF01867 (1)	26	12
	2.1	7.5	—	CHF01868 (1)	CHF01869 (1)	CHF01870 (1)	CHF01871 (1)	26	12
	2.1	9	—	CHF01872 (1)	CHF01873 (1)	CHF01874 (1)	CHF01875 (1)	27	12
	2.2	12	—	—	CHF01877 (1)	CHF01878 (1)	CHF01879 (1)	34	15
	2.2	15	—	—	CHF01881 (1)	CHF01882 (1)	CHF01883 (1)	35	16
	2.3	18	—	—	CHF01885 (1)	CHF01886 (1)	CHF01887 (1)	43	20
3"-150lb 3 elements	3.1	6	—	CHF01888 (1)	CHF01889 (1)	CHF01890 (1)	CHF01891 (1)	52	24
	3.1	9	—	CHF01892 (1)	CHF01893 (1)	CHF01894 (1)	CHF01895 (1)	53	24
	3.2	12	—	—	CHF01896 (1)	CHF01897 (1)	CHF01898 (1)	61	28
	3.2	15	—	—	CHF01899 (1)	CHF01900 (1)	CHF01901 (1)	67	30
	3.3	18	—	—	CHF01902 (1)	CHF01903 (1)	CHF01904 (1)	74	34
4"-150lb 6 elements	4.1	12	—	CHF01905 (2)	CHF01906 (1)	CHF01907 (1)	CHF01908 (1)	77	35
	4.1	18	—	CHF01909 (2)	CHF01910 (1)	CHF01911 (1)	CHF01912 (1)	79	36
	4.2	24	—	CHF01913 (2)	CHF01914 (2)	CHF01915 (2)	CHF01916 (1)	92	42
	4.2	30	—	—	CHF01917 (2)	CHF01918 (2)	CHF01919 (1)	94	43
	4.3	36	—	—	CHF01920 (2)	CHF01921 (2)	CHF01922 (1)	117	53
	4.3	50	—	—	—	—	CHF01923 (2)	121	55
	4.4	60	—	—	—	—	CHF01924 (2)	145	66
5"-150lb 6 elements	5.1	24	—	CHF01925 (2)	CHF01926 (2)	CHF01927 (2)	CHF01928 (1)	115	52
	5.1	30	—	—	CHF01929 (2)	CHF01930 (2)	CHF01931 (1)	117	53
	5.2	36	—	—	CHF01932 (2)	CHF01933 (2)	CHF01934 (1)	128	58
	5.3	50	—	—	—	—	CHF01935 (2)	167	76
	5.4	60	—	—	—	—	CHF01936 (2)	196	89
5"-150lb 9 elements	5.1	36	—	—	CHF01937 (3)	CHF01938 (3)	CHF01939 (3)	120	54
	5.1	45	—	—	CHF01940 (3)	CHF01941 (3)	CHF01942 (3)	122	55
	5.2	54	—	—	CHF01943 (3)	CHF01944 (3)	CHF01945 (3)	134	61
	5.3	75	—	—	—	—	CHF01946 (3)	176	80
	5.4	90	—	—	—	—	CHF01947 (3)	197	89
6"-150lb 12 elements	6.1	24	—	CHF01948 (2)	CHF01949 (2)	CHF01950 (2)	CHF01951 (1)	125	57
	6.1	36	—	CHF01952 (3)	CHF01953 (2)	CHF01954 (2)	CHF01955 (1)	129	59
	6.2	48	—	—	CHF01956 (4)	CHF01957 (3)	CHF01958 (2)	153	69
	6.2	60	—	—	CHF01959 (4)	CHF01960 (3)	CHF01961 (2)	157	71
	6.3	72	—	—	CHF01962 (4)	—	CHF01963 (2)	196	89
	6.3	100	—	—	—	—	CHF01964 (2)	204	93
	6.4	120	—	—	—	—	CHF01965 (4)	246	112
6"-150lb 15 elements	6.1	30	—	CHF01966 (3)	CHF01967 (5)	CHF01968 (3)	CHF01969 (1)	128	58
	6.1	45	—	CHF01970 (5)	CHF01971 (5)	CHF01972 (3)	CHF01973 (5)	133	60
	6.2	60	—	—	CHF01974 (5)	CHF01975 (3)	CHF01976 (5)	158	72
	6.2	75	—	—	CHF01977 (5)	CHF01978 (5)	CHF01979 (5)	163	74
	6.3	90	—	—	CHF01980 (5)	—	CHF01981 (5)	202	92
	6.3	125	—	—	—	—	CHF01982 (5)	213	97
	6.4	150	—	—	—	—	CHF01983 (5)	257	117
8"-150lb 18 elements	8.1	50	—	—	CHF01984 (3)	CHF01985 (3)	CHF01986 (2)	210	95
	8.2	75	—	—	CHF01987 (6)	—	CHF01988 (2)	238	108
	8.3	100	—	—	CHF01989 (6)	—	CHF01990 (3)	266	121
	8.4	125	—	—	CHF01991 (6)	—	CHF01992 (6)	294	133
	8.5	150	—	—	—	—	CHF01993 (6)	326	148
	8.6	175	—	—	—	—	CHF01994 (6)	358	162
	8.7	200	—	—	—	—	CHF01995 (6)	391	177

(C\*) = Number of Branch Circuits per heater

### Standard (Non-Stock) Circulation Heaters

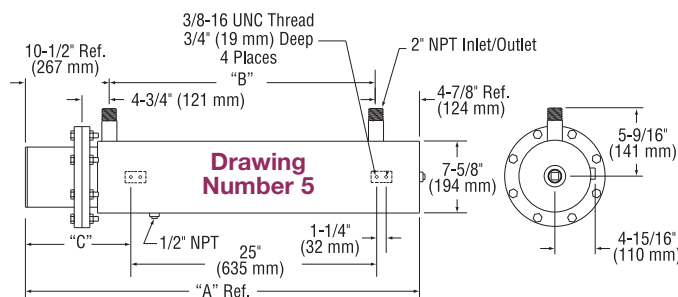
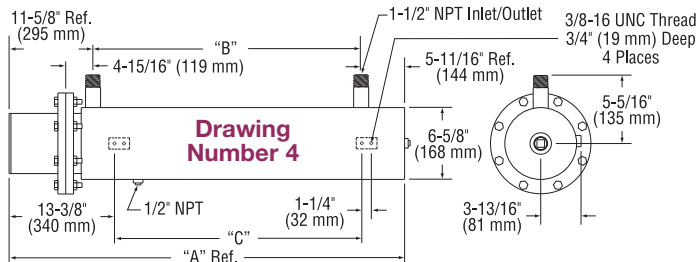
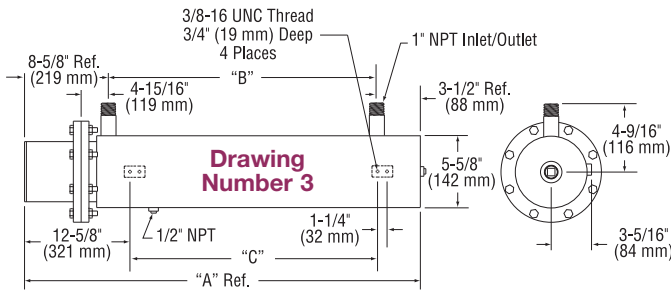
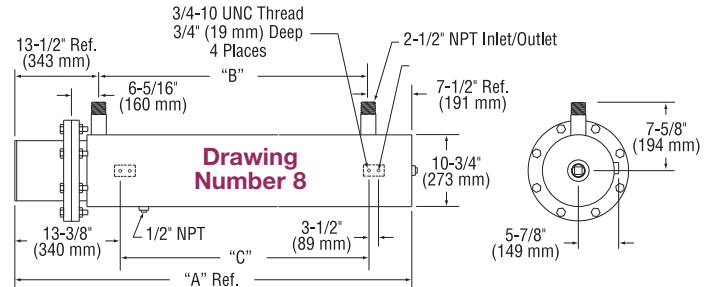
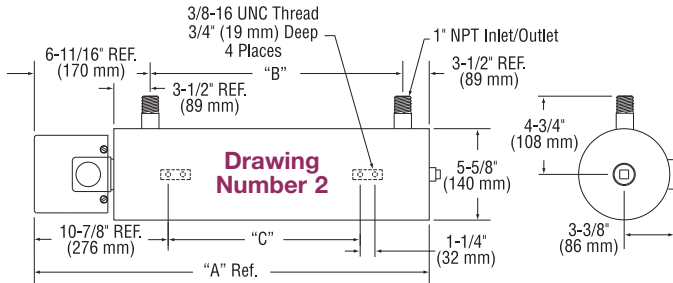
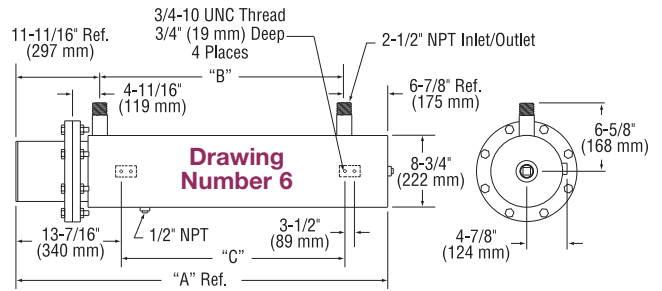
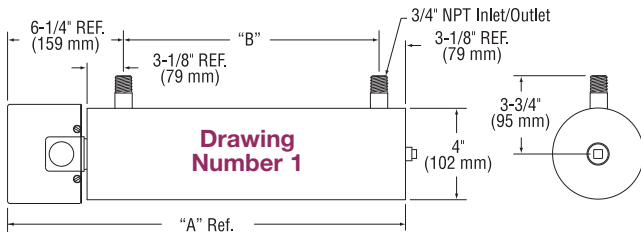

### Dimensional Drawing Number

Drawing Number	"A"		"B"		"C"	
	in	mm	in	mm	in	mm
1.1	24-3/8	619	15	381		
1.2	32-3/8	822	23	584		
2.1	32-11/16	830	22-1/2	572	16-1/2	419
2.2	42-11/16	1084	32-1/2	826	26-1/2	673
2.3	55-3/16	1402	45	1143	39	991
3.1	34-5/8	879	22-1/2	572	16-1/2	419
3.2	44-5/8	1133	32-1/2	826	26-1/2	673
3.3	57-1/8	1451	45	1143	39	991
4.1	37-13/16	960	20-1/2	521	17	432
4.2	48-5/16	1227	31	787	27-1/2	699
4.3	69-5/16	1761	52	1321	48-1/2	1232
4.4	90-5/16	2294	73	1854	69-1/2	1765
5.1	45-3/8	1153	30	762	11-1/2	292
5.2	52-3/8	1330	37	940	15-1/4	387
5.3	63-7/8	1622	48-1/2	1232	21	533
5.4	77-1/4	1962	61-7/8	1572	27-1/2	698
6.1	39-1/16	992	20-1/2	521	17	432
6.2	49-9/16	1259	31	787	27-1/2	699
6.3	70-9/16	1792	52	1321	48-1/2	1232
6.4	91-9/16	2326	73	1854	69-1/2	1765
8.1	46	1168	24-11/16	627	21-3/16	538
8.2	53-3/4	1365	32-11/16	830	29-3/16	741
8.3	60-3/4	1543	39-11/16	1008	36-3/16	919
8.4	68-3/4	1746	47-5/16	1202	43-13/16	1113
8.5	77-7/8	1978	56-13/16	1443	53-5/16	1354
8.6	86-7/8	2207	65-13/16	1672	62-5/16	1583
8.7	96-7/8	2461	75-13/16	1926	72-5/16	1837



**Note:** Circulation heater mounting lug design and location in the assembly drawings shown are standard. Designs can be modified to fit customer installation. Consult Tempco with your requirements.

### Ordering Information

See Page 11-69 for complete Ordering Information.

### Standard (Non-Stock) Circulation Heaters

**60 watts/in<sup>2</sup> (9.3 watts/cm<sup>2</sup>) — Typical Applications: Deionized Water • Demineralized Water**

- \* 316 Stainless Steel Screw Plug and 316 Stainless Steel 150-lb Flanged Heater Sizes
- \* 316 Stainless Steel Tank

- \* 316 Stainless Steel Sheath Heating Elements
- \* NEMA 1 Terminal Housing

Nominal Pipe Size	Dimensional Drawing Number	KW	Part Number					Approximate Net Weight	
			120V	240V-1Ph (C*)	240V-3Ph (C*)	480V-1Ph (C*)	480V-3Ph (C*)	lbs	kgs
2½" NPT 3 elements	2.1	6	—	CHF01996 (1)	CHF01997 (1)	CHF01998 (1)	CHF01999 (1)	28	13
	2.1	7.5	—	CHF02000 (1)	CHF02001 (1)	CHF02002 (1)	CHF02003 (1)	28	13
	2.1	9	—	CHF02004 (1)	CHF02005 (1)	CHF02006 (1)	CHF02007 (1)	29	13
	2.2	12	—	—	CHF02009 (1)	CHF02010 (1)	CHF02011 (1)	36	16
	2.2	15	—	—	CHF02013 (1)	CHF02014 (1)	CHF02015 (1)	37	17
	2.3	18	—	—	CHF02017 (1)	CHF02018 (1)	CHF02019 (1)	38	17
	4"-150lb 6 elements	4.1	12	—	—	CHF02021 (1)	CHF02022 (1)	CHF02023 (1)	77
4.1		18	—	—	CHF02025 (1)	CHF02026 (1)	CHF02027 (1)	79	36
4.2		24	—	—	CHF02029 (2)	CHF02030 (2)	CHF02031 (1)	92	42
4.2		30	—	—	CHF02032 (2)	CHF02033 (2)	CHF02034 (1)	94	42
4.3		36	—	—	CHF02035 (2)	CHF02036 (2)	CHF02037 (1)	117	53
4.3		50	—	—	—	—	CHF02038 (2)	121	55
4.4		60	—	—	—	—	CHF02039 (2)	145	66
6"-150lb 12 elements	6.1	24	—	CHF02040 (3)	CHF02041 (2)	CHF02042 (2)	CHF02043 (1)	126	57
	6.1	36	—	CHF02044 (3)	CHF02045 (2)	CHF02046 (2)	CHF02047 (1)	130	59
	6.2	48	—	—	CHF02048 (4)	CHF02049 (3)	CHF02050 (2)	153	69
	6.2	60	—	—	CHF02051 (4)	CHF02052 (3)	CHF02053 (2)	157	71
	6.3	72	—	—	CHF02054 (4)	—	CHF02055 (2)	196	89
	6.3	100	—	—	—	—	CHF02056 (4)	205	93
	6.4	120	—	—	—	—	CHF02057 (4)	246	112
6"-150lb 15 elements	6.1	30	—	CHF02058 (3)	CHF02059 (5)	CHF02060 (3)	CHF02061 (1)	128	58
	6.1	45	—	CHF02062 (5)	CHF02063 (5)	CHF02064 (3)	CHF02065 (5)	133	60
	6.2	60	—	—	CHF02066 (5)	CHF02067 (3)	CHF02068 (5)	158	72
	6.2	75	—	—	CHF02069 (5)	CHF02070 (5)	CHF02071 (5)	163	74
	6.3	90	—	—	CHF02072 (5)	—	CHF02073 (5)	202	92
	6.3	125	—	—	—	—	CHF02074 (5)	213	97
	6.4	150	—	—	—	—	CHF02075 (5)	257	117

(C\*) = Number of Branch Circuits per heater





### Standard (Non-Stock) Circulation Heaters

#### Dimensional Drawing Number

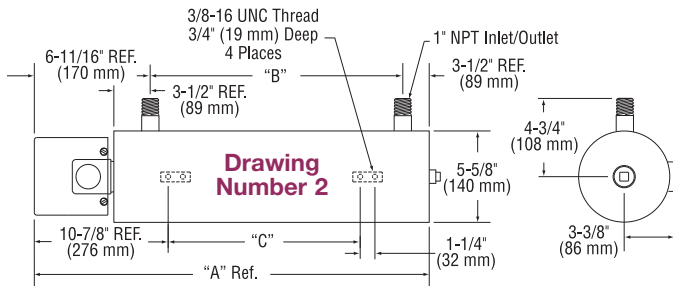

Drawing Number	"A"		"B"		"C"	
	in	mm	in	mm	in	mm
2.1	32-11/16	830	22-1/2	572	16-1/2	419
2.2	42-11/16	1084	32-1/2	826	26-1/2	673
2.3	55-3/16	1402	45	1143	39	991
4.1	37-13/16	960	20-1/2	521	17	432
4.2	48-5/16	1227	31	787	27-1/2	699
4.3	69-5/16	1761	52	1321	48-1/2	1232
4.4	90-5/16	2294	73	1854	69-1/2	1765
6.1	39-1/16	992	20-1/2	521	17	432
6.2	49-9/16	1259	31	787	27-1/2	699
6.3	70-9/16	1792	52	1321	48-1/2	1232
6.4	91-9/16	2326	73	1854	69-1/2	1765



**Note:** Circulation heater mounting lug design and location in the assembly drawings shown are standard. Designs can be modified to fit customer installation. Consult Tempco with your requirements.

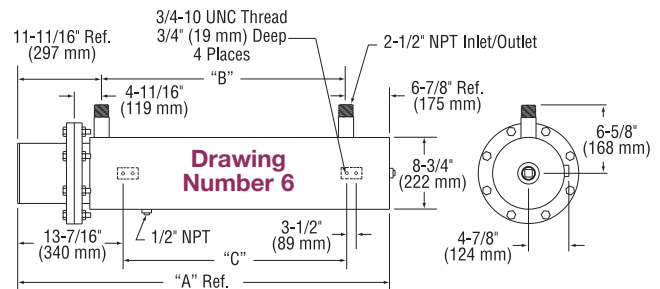
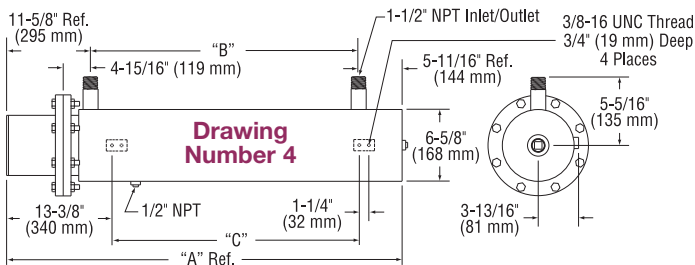

#### Ordering Information

##### Catalog Heaters

Order by Part Number for catalog heaters listed on pages 11-51 through 11-68.

**Standard lead time is 4-5 weeks.**

##### Custom Engineered/Manufactured Heaters

For sizes and ratings not listed, **TEMPCO** will design and manufacture a Circulation Heater to meet your requirements. **Please Specify** the following:

- Application, including operating temperature/pressure
- Wattage, Voltage and Phase
- Screw Plug or Flange Size and Material
- Element Sheath Material
- Element Watt Density
- Element Immersion Length
- Electrical Enclosure Type
- Thermostat— if required
- Vessel Material
- Additional Insulation
- Flow Control Baffles
- Other Optional Features

**WARNING:** Cancer and Reproductive Harm - [www.P65Warnings.ca.gov](http://www.P65Warnings.ca.gov).

### Mightybooster™ Circulation Heater — Point of Use

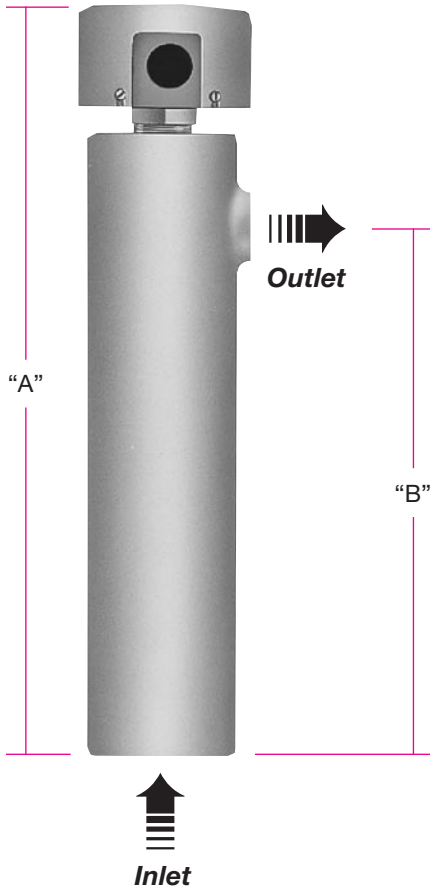

#### Design Features

- \* Integral 60°F (15°C) to 180°F (82°C) Thermostat
- \* NEMA 1 Terminal Housing
- \* Insulated Carbon Steel or Bronze Vessel
- \* 1" NPT Inlet and Outlet
- \* Copper Sheath Heating Elements and Brass Screw Plug
- \* Watt Density of 60 watts/in<sup>2</sup> (9.3 watts/cm<sup>2</sup>)

#### Typical Heating Application: Clean Water • Aqueous Solutions

Vessel Material	KW	"A" OAL		"B" Inlet-Outlet		Part Number 120/240V	Approximate Net Weight	
		in	mm	in	mm		lbs	kgs
Carbon Steel	1.5	18	457	12 <sup>3</sup> / <sub>8</sub>	314	CHF02097	8	3.6
	2.0	18	457	12 <sup>3</sup> / <sub>8</sub>	314	CHF02098	8	3.6
	2.5	22	559	16 <sup>3</sup> / <sub>8</sub>	416	CHF02099	11	5.0
	3.0	22	559	16 <sup>3</sup> / <sub>8</sub>	416	CHF02100	11	5.0
Bronze	1.5	18	457	12 <sup>3</sup> / <sub>8</sub>	314	CHF02101	12.5	5.7
	2.0	18	457	12 <sup>3</sup> / <sub>8</sub>	314	CHF02102	12.5	5.7
	2.5	22	559	16 <sup>3</sup> / <sub>8</sub>	416	CHF02103	14.5	6.6
	3.0	22	559	16 <sup>3</sup> / <sub>8</sub>	416	CHF02104	14.5	6.6

#### Design Features

- \* Integral 150°F (65°C) to 560°F (300°C) Thermostat
- \* NEMA 1 Terminal Housing
- \* Insulated Carbon Steel Vessel
- \* 1" NPT Inlet and Outlet
- \* Steel Sheath Heating Elements and Steel Screw Plug
- \* Watt Density of 23 watts/in<sup>2</sup> (3.6 watts/cm<sup>2</sup>)

#### Typical Heating Application: Lubricating Oils

Vessel Material	KW	"A" OAL		"B" Inlet-Outlet		Part Number 120/240V	Approximate Net Weight	
		in	mm	in	mm		lbs	kgs
Carbon Steel	0.5	22	559	16 <sup>3</sup> / <sub>8</sub>	416	CHF02105	11	5.0
	0.75	22	559	16 <sup>3</sup> / <sub>8</sub>	416	CHF02106	11	5.0
	1.0	22	559	16 <sup>3</sup> / <sub>8</sub>	416	CHF02107	11	5.0

### Ordering Information

#### Catalog Heaters

Order by Part Number for catalog heaters listed above.  
**Standard lead time is 3-4 weeks.**

#### Custom Engineered/Manufactured Heaters

For ratings not listed, **TEMPCO** will design and manufacture a Mightybooster Heater to meet your requirements.

**Please Specify** the following:

- |  |  |
|--|--|
| <input type="checkbox"/> Application, including operating temperature/pressure | <input type="checkbox"/> Element Immersion Length  |
| <input type="checkbox"/> Wattage and Voltage                                   | <input type="checkbox"/> Electrical Enclosure Type |
| <input type="checkbox"/> Screw Plug Material                                   | <input type="checkbox"/> Thermostat — if required  |
| <input type="checkbox"/> Element Sheath Material                               | <input type="checkbox"/> Vessel Material           |
| <input type="checkbox"/> Element Watt Density                                  | <input type="checkbox"/> Additional Insulation     |
|  | <input type="checkbox"/> Other Optional Features   |

**WARNING:** Cancer and Reproductive Harm - [www.P65Warnings.ca.gov](http://www.P65Warnings.ca.gov).

### Process Circulation Heating Systems

**TEMPCO Circulation Systems** include a circulation heater and power control panel skid mounted in a compact package to use minimal floor space. Heater vessel is carbon steel and can be vertically or horizontally mounted.

The pre-wired panel contains a process temperature control and a manual reset over-temperature control. The Zero Cross SCR power controller provides proportional power to the heater load for precise temperature control.

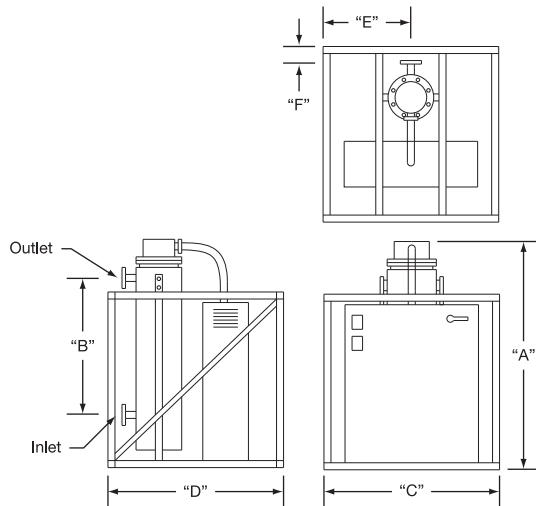

#### Design Features

- \* 150-lb Flanged Heater Sizes
- \* Steel Sheath Heating Elements
- \* NEMA 1 Terminal Housing
- \* Watt Density of 15 watts/in<sup>2</sup> (2.3 watts/cm<sup>2</sup>)
- \* NEMA 12 Control Panel with Main Fused Disconnect, Door Interlock and FM High Limit Cutout



#### Standard (Non-Stock) Vertically Mounted Process Circulation Heating Systems

**Typical Heating Applications: Medium Weight Oils • Heat Transfer Oils**

KW	Heater Flange Size	In-Out Pipe Size	"A"		"B"		"C"		"D"		"E"		"F"		Part Number	
			in	mm	in	mm	in	mm	in	mm	in	mm	in	mm	240V-3Ph	480V-3Ph
10	5"	2"	46	1168	25	635	39	991	13	330	8	203	43	1092	CHS02076	CHS02077
15	5"	2"	58	1473	37	940	39	991	13	330	8	203	57	1448	CHS02078	CHS02079
20	5"	2"	71	1803	50	1270	39	991	13	330	8	203	70	1778	CHS02080	CHS02081
25	5"	2"	83	2102	62	1575	39	991	13	330	8	203	82	2083	CHS02082	CHS02083
30	8"	2½"	52	1321	25	635	42	1067	14	356	13	330	45	1143	CHS02084	CHS02085
40	8"	2½"	65	1651	37	940	42	1067	14	356	13	330	59	1499	CHS02086	CHS02087
55	8"	2½"	77	1956	50	1270	42	1067	14	356	13	330	72	1829	CHS02088	CHS02089
70	8"	2½"	90	2286	62	1575	42	1067	14	356	13	330	84	2134	CHS02090	CHS02091
90	10"	4"	108	2743	75	1905	44	1118	19	483	14	356	102	2591	CHS02092	CHS02093
110	12"	5"	96	2438	62	1575	46	1168	19	483	15	381	89	2261	—	CHS02094
150	14"	6"	97	2464	62	1575	48	1219	19	483	16	406	89	2261	—	CHS02095
180	14"	6"	110	2794	75	1905	48	1219	19	483	16	406	102	2591	—	CHS02096

**NOTE:** Dimensions are approximate

#### Ordering Information

##### Catalog Heaters

Order by Part Number for catalog heaters.

**Standard lead time is 6-7 weeks.**

##### Custom Engineered/Manufactured Heaters

For sizes and ratings not listed, **TEMPCO** will design and manufacture a Circulation System to meet your requirements. **Please Specify** the following:

- |  |  |
|--|--|
| <input type="checkbox"/> Maximum temperature rise and operating pressure     | <input type="checkbox"/> Vessel material (carbon steel or stainless steel) |
| <input type="checkbox"/> Inlet-Outlet size and type                          | <input type="checkbox"/> Element Watt density                              |
| <input type="checkbox"/> Vertical or horizontal mounting                     | <input type="checkbox"/> Wattage (up to 600KW), Voltage, Phase             |
| <input type="checkbox"/> Element sheath material (Steel, Incoloy® or Copper) |  |

**WARNING:** Cancer and Reproductive Harm - [www.P65Warnings.ca.gov](http://www.P65Warnings.ca.gov).