

Instructions for Tempco Control Enclosure PCM10001 through PCM10004

Temperature Controller: Model TEC-9100, 1/16 DIN, Dual Display with PID Auto-tuning

Main Power Switch: Located on Front Panel

Part Number	Input Voltage (50/60 Hz)	Max. Amperage	Heater Fusing	Maximum Wattage	Thermocouple Sensor Input
PCM10001	120VAC	16	20amps	1920	Type J
PCM10002	240VAC	16	20amps	3840	Type J
PCM10003	120VAC	16	20amps	1920	Type K
PCM10004	240VAC	16	20amps	3840	Type K

- 1: TEC-9100 Controller
- 2: On-Off Switch
- 3: 1 Amp Control Fuse (240V model has 2)
- 4: 20 Amp Main Fuse (240V model has 2)
- 5: 120V or 240V Power Cord (20A)
- 6: 120V or 240V Heater Receptacle (20A)
- 7: Type J or K Thermocouple Jack - Black= J, Yellow= K

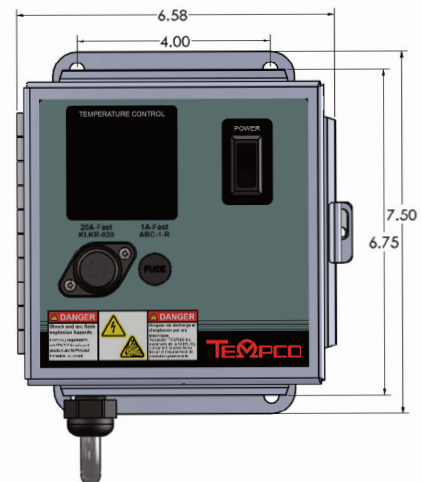
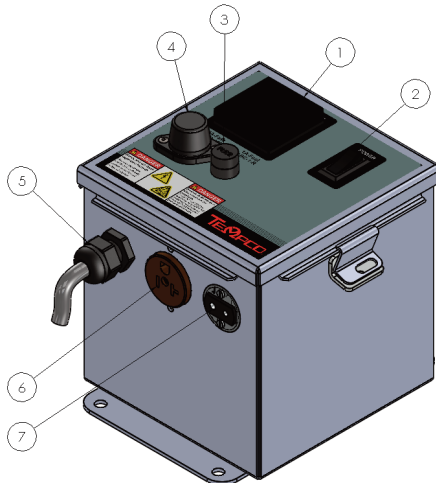

WARNINGS

- Dangerous voltage capable of causing injury or death is present within this enclosure. Power to all equipment must be disconnected before installation or beginning any troubleshooting procedures. **All wiring and component replacement must be made by qualified personnel only.**
- To minimize the possibility of fire or shock, do not expose this console to rain or excessive moisture.
- Do not use this enclosure in areas where hazardous conditions exist such as excessive shock, vibration, dirt, corrosive gases, oil or where explosive gases or vapors are present.

WIRING (for safety, unplug unit prior to making any heater or sensor connections)

1. Attach the leads from your thermocouple to the provided standard thermocouple jack of the same thermocouple type. **Note the correct polarity:** For type “J” and “K thermocouples, the **RED** lead is (-) negative.
2. The heater output current is sourced directly thru the line cord. The bottom console output receptacle provides live controlled power for direct connection to your heater(s).

OPERATION

1. Verify the power switch is in the off position. Plug your heater into the straight-blade enclosure connector. Plug the provided line cord from the console into a standard outlet. Switch on the enclosure.
2. Using the up & down pushbuttons on the TEC-9100 controller, start out with the temperature set low to test your system. If the setpoint temperature is being maintained, set your desired temperature setpoint.

Note: The signal of the output circuit is wired through output 2 of the TEC-9100 which can be used as a cut-out in the event of an over-setpoint temperature condition. This is a deviation contact set to 30° F above the setpoint.

In the event of an over-setpoint temperature condition, output 2 will open, cutting the control signal to the output relay.

This deviation setpoint can be changed by accessing “SP2” in the TEC-9100 (note page 3 for user menu selection). This is not meant to be a redundant safety controller. Refer to our TEC-910 for a safety controller.

3. Auto-tuning is recommended for initial set-up. Refer to page 7 of the attached manual for auto-tuning procedures.

SPARE/REPLACEMENT PARTS

Part Number	Description
EHD-124-245	(1 or 2) Main fuse(s) rated 20 amps, 250V, Class CC, fast acting, Littelfuse KLKR020 or equivalent.
EHD-124-276	Control fuse (1) rated 1 amp, 250V, 1/4 x 1¼", fast acting, Bussmann ABC-1-R or equivalent.
EHD-102-140	Output plug — 20A 125V, 2-pole, 3-wire grounding, NEMA 5-20P (PCM10001, PCM10003)
EHD-102-187	Output plug — 20A 250V, 2-pole, 3-wire grounding, NEMA 6-20P (PCM10002, PCM10004)
TCA-101-101	Thermocouple plug, Type “J” (if PCM10001, PCM10002)
TCA-101-102	Thermocouple plug, Type “K” (if PCM10003, PCM10004)

1-3 Programming Port

The TEC99011 cable and TEC99003 network adapter can be used to connect the programming port to a PC for automatic configuration.

The programming port is used for off-line automatic setup and testing procedures only. Don't attempt to make any connection to these pins when the unit is used for a normal control purpose.

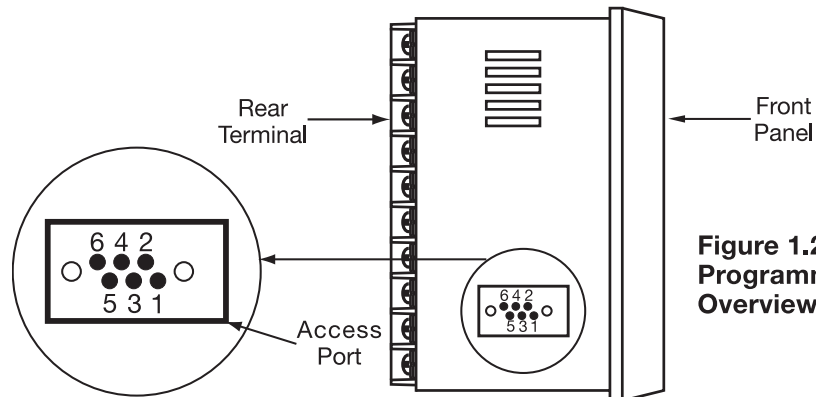

Figure 1.2
Programming Port Overview

1-4 Keys and Displays

KEYPAD OPERATION

SCROLL KEY:

This key is used to select a parameter to be viewed or adjusted.

UP KEY:

This key is used to increase the value of the selected parameter.

DOWN KEY:

This key is used to decrease the value of the selected parameter.

RESET KEY:

This key is used to:

1. Revert the display to show the process value.
2. Reset the latching alarm, once the alarm condition is removed.
3. Stop the manual control mode, auto-tuning mode, and calibration mode.
4. Clear the message of communication error and auto-tuning error.
5. Restart the dwell timer when the dwell timer has timed out.
6. Enter the manual control menu when in failure mode.

ENTER KEY: Press

Press

1. Enter setup menu. The display shows
2. Enter manual control mode—when manual control mode
3. Enter auto-tuning mode—when auto-tuning mode
4. Perform calibration to a selected parameter during the calibration procedure.
 - Press
 - Press
 - Press

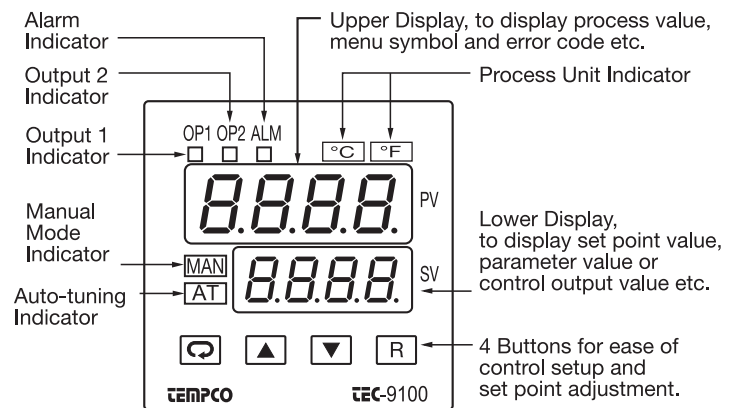

Figure 1.3 Front Panel Description

Table 1.1 Display Form of Characters

A	<i>A</i>	E	<i>E</i>	I	,	N	<i>n</i>	S	<i>S</i>	X	
B	<i>b</i>	F	<i>F</i>	J	<i>J</i>	O	<i>o</i>	T	<i>t</i>	Y	<i>Y</i>
C	<i>C</i>	G	<i>G</i>	K	<i>K</i>	P	<i>P</i>	U	<i>u</i>	Z	
c	<i>c</i>	H	<i>H</i>	L	<i>L</i>	Q		V	<i>v</i>	?	<i>?</i>
D	<i>d</i>	h	<i>h</i>	M	<i>m</i>	R	<i>r</i>	W		=	<i>=</i>

▴ Indicates Abstract Characters

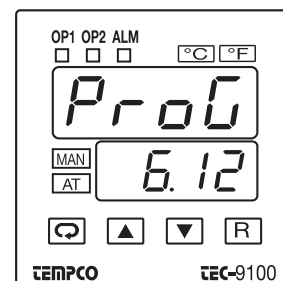
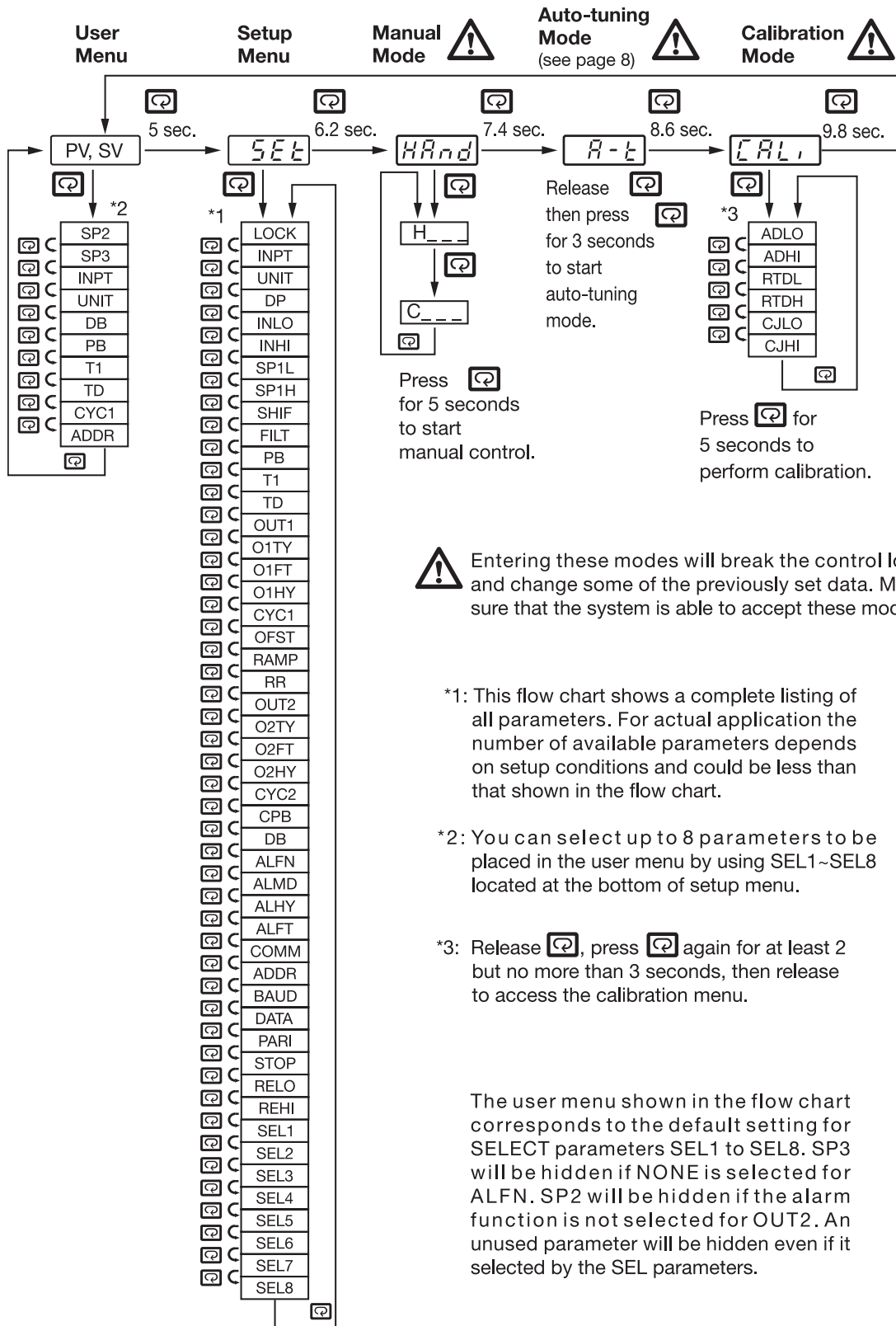

Figure 1.4
Display during Power Up

Display program code of the product for 2.5 seconds.

The left diagram shows program number 6 for TEC-9100 with version 12.

1-5 Menu Overview



! Entering these modes will break the control loop and change some of the previously set data. Make sure that the system is able to accept these modes.

*1: This flow chart shows a complete listing of all parameters. For actual application the number of available parameters depends on setup conditions and could be less than that shown in the flow chart.

*2: You can select up to 8 parameters to be placed in the user menu by using SEL1~SEL8 located at the bottom of setup menu.

*3: Release , press  again for at least 2 but no more than 3 seconds, then release to access the calibration menu.

The user menu shown in the flow chart corresponds to the default setting for SELECT parameters SEL1 to SEL8. SP3 will be hidden if NONE is selected for ALFN. SP2 will be hidden if the alarm function is not selected for OUT2. An unused parameter will be hidden even if it selected by the SEL parameters.

Parameter Descriptions (TEC-9100 Temperature Controller)

Parameter Notation	Parameter Description (Refer to Page)	Range	Default Value
<i>SP1</i> SP1	Set point for output 1	Low: SP1L High: SP1H	77.0°F (25.0°C)
<i>SP2</i> SP2	Set point for output 2 when output 2 performs alarm function	Low: -19999 High: 45536	30.0°F (-17.7°C)
<i>LOCK</i> LOCK	Select parameters to be locked out	0) <i>none</i> : No parameters are locked 1) <i>SEt</i> : Setup data is locked 2) <i>uSEr</i> : Setup data and User data except Set point are locked 3) <i>ALL</i> : All data are locked	0
<i>INPT</i> INPT	Input sensor selection	0) <i>J-TC</i> : J type thermocouple 1) <i>K-TC</i> : K type thermocouple	*
<i>UNIT</i> UNIT	Input unit selection	0) <i>C</i> : Degree C unit 1) <i>F</i> : Degree F unit 2) <i>Pu</i> : Process unit	1
<i>DP</i> DP	Decimal point selection	0) <i>noDP</i> : No decimal point 1) <i>1-dP</i> : 1 decimal digit 2) <i>2-dP</i> : 2 decimal digits 3) <i>3-dP</i> : 3 decimal digits	0
<i>SP1L</i> SP1L	Low limit of set point	Low: -19999 High: 45536	0°F (-17.8°C)
<i>SP1H</i> SP1H	High limit of set point value	Low: SP1L High: 45536	1000°F (538°C)
<i>SHIF</i> SHIF	PV shift (offset) value (Page 7)	Low: -360.0°F (-200.0°C) High: 360.0°F (200.0°C)	0.0
<i>FILT</i> FILT	Filter damping time constant of PV	0) <i>0</i> : 0 second time constant 1) <i>0.2</i> : 0.2 second time constant 2) <i>0.5</i> : 0.5 second time constant 3) <i>1</i> : 1 second time constant 4) <i>2</i> : 2 seconds time constant 5) <i>5</i> : 5 seconds time constant 6) <i>10</i> : 10 seconds time constant 7) <i>20</i> : 20 seconds time constant 8) <i>30</i> : 30 seconds time constant 9) <i>60</i> : 60 seconds time constant	2

* 0) *J_TC*: J Type for PCM10001 and PCM10002
1) *K_TC*: K Type for PCM10003 and PCM10004

Parameter Notation	Parameter Description (Refer to Page)	Range	Default Value
<i>Pb</i> PB	Proportional band value (Page 8)	Low: 0 High: 900.0°F (500.0°C)	18.0°F (10.0°C)
<i>ti</i> TI	Integral time value	Low: 0 High: 1000 sec	100
<i>td</i> TD	Derivative time value	Low: 0 High: 360.0 sec	25.0
<i>OUT1</i> OUT1	Output 1 function	0) <i>REv</i> : Reverse (heating) control action 1) <i>dir</i> : Direct (cooling) control action	0
<i>O1TY</i> O1TY	Output 1 signal type	0) <i>RELY</i> : Relay output 1) <i>SSrd</i> : Solid state relay drive output 2) <i>SSr</i> : Solid state relay output 3) <i>4-20</i> : 4-20 mA DC 4) <i>0-20</i> : 0 - 20 mA DC 5) <i>0-1V</i> : 0 - 1V DC 6) <i>0-5V</i> : 0 - 5V DC 7) <i>1-5V</i> : 1 - 5V DC 8) <i>0-10</i> : 0 - 10V DC	0
<i>O1FT</i> O1FT	Output 1 failure transfer mode (Page 7)	Select BPLS (bumpless transfer) or 0.0 - 100.0% to continue output 1 control function as the unit fails, or select OFF (0) or ON (1) for ON-OFF control.	0
<i>O1HY</i> O1HY	Output 1 ON-OFF hysteresis	Low: 0.1 High: 90°F (50.0°C)	0.2°F (0.1°C)
<i>CYC1</i> CYC1	Output 1 cycle time	Low: 0.1 High: 90.0 sec.	18.0
<i>OFST</i> OFST	Offset value for P control	Low: 0 High: 100.0%	25.0
<i>RAMP</i> RAMP	Ramp function selection (Page 15)	0) <i>none</i> : No ramp function 1) <i>unit</i> : Use unit/minute as Ramp Rate 2) <i>hour</i> : Use unit/hour as Ramp Rate	0
<i>RR</i> RR	Ramp rate (Page 7)	Low: 0 High: 900.0°F (500.0°C)	0.0
<i>OUT2</i> OUT2	Output 2 function	0) <i>none</i> : Output 2 No Function 2) <i>dEH</i> : Deviation High 3) <i>dELo</i> : Deviation Low 6) <i>PuH</i> : Process High 7) <i>PuLo</i> : Process Low 8) <i>COOL</i> : Cooling PID Function	2
<i>O2TY</i> O2TY	Output 2 signal type	0) <i>RELY</i> : Relay output 1) <i>SSrd</i> : Solid state relay drive output 2) <i>SSr</i> : Solid state relay output 3) <i>4-20</i> : 4-20 mA DC 4) <i>0-20</i> : 0 - 20 mA DC 5) <i>0-1V</i> : 0 - 1V DC 6) <i>0-5V</i> : 0 - 5V DC 7) <i>1-5V</i> : 1 - 5V DC 8) <i>0-10</i> : 0 - 10V DC	0
<i>O2FT</i> O2FT	Output 2 failure transfer mode	Select BPLS (bumpless transfer) or 0.0 - 100.0% to continue output 2 control function as the unit fails, or select OFF (0) or ON (1) for alarm function.	0
<i>O2HY</i> O2HY	Output 2 hysteresis value when output 2 performs alarm function	Low: 0.1 High: 90.0°F (50.0°C)	0.2°F (0.1°C)

Control Outputs

Heat only ON-OFF control: Select REVR for OUT1. Set PB (proportional band) to 0. O1HY is used to adjust dead band for ON-OFF control. The output 1 hysteresis (O1HY) is enabled in case PB=0. The heat only on-off control function is shown in the following diagram:

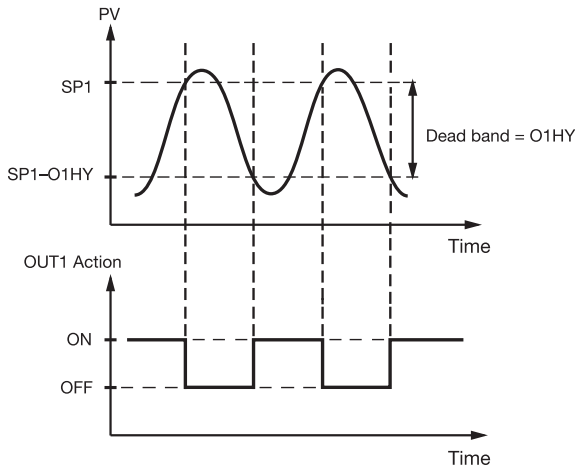

Figure 3.2 Heat Only ON-OFF Control

The ON-OFF control may introduce excessive process oscillation even if hysteresis is minimized. If ON-OFF control is set (i.e., PB=0), TI, TD, CYC1, OFST, CYC2, CPB, and DB will be hidden and have no function in the system. The auto-tuning and bumpless transfer functions will be disabled as well.

Heat only P (or PD) control: Select REVR for OUT1, set TI to 0. OFST is used to adjust the control offset (manual reset).

O1HY is hidden if PB is not equal to 0.

OFST function: OFST is measured by % with a range of 0–100.0%. In the steady state (i.e., process has been stabilized), if the process value is lower than the set point by a definite value, say 5°C, while 20°C is used for PB, that is lower by 25%, then increase OFST 25%, and vice-versa. After adjusting OFST value, the process value will be varied and eventually coincide with set point.

Refer to section 3-12 “manual tuning” for the adjustment of PB and TD. Manual reset (adjust OFST) is not practical because the load may change from time to time and OFST may need to be adjusted repeatedly. PID control can avoid this situation.

Heat only PID control: If REVR is selected for OUT1, PB and TI should not be zero. Perform auto-tuning for the new process, or set PB, TI, and TD with historical values. See section 3-11 for auto-tuning operation. If the control result is still unsatisfactory, then use manual tuning to improve control. See section 3-12 for manual tuning. The unit contains a very advanced PID and Fuzzy Logic algorithm to create a very small overshoot and very quick response to the process if it is properly tuned.

Cool only control: ON-OFF control, P (PD) control, and PID control can be used for cool control. Set OUT1 to DIRT (direct action). The other functions for cool only ON-OFF control, cool only P (PD) control, and cool only PID control are the same as for heat only control except that the output variable (and action) for cool control is inverse to heat control.

NOTE: ON-OFF control may result in excessive overshoot and undershoot problems in the process. P (or PD) control will result in a deviation of process value from the set point. It is recommended to use PID control for heat-cool control to produce a stable and zero offset process value.

Ramp

The ramping function is performed during power up as well as any time the set point is changed. If MINR or HRR is chosen for RAMP, the unit will perform the ramping function. The ramp rate is programmed by adjusting RR. The ramping function is disabled as soon as failure mode, manual control mode, auto-tuning mode or calibration mode is entered.

Example without dwell timer

Select MINR for RAMP, select °C for UNIT, select 1-DP for DP, set RR=10.0. SV is set to 200°C initially, and changed to 100°C 30 minutes after power-up. The starting temperature is 30°C. After power-up, the process runs like the curve shown below:

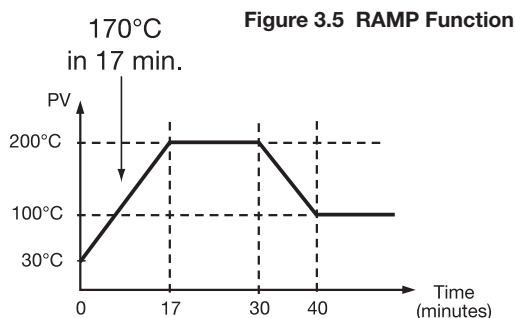

Figure 3.5 RAMP Function

Note: When the ramp function is used, the lower display will show the current ramping value. The ramping value is an artificially determined setpoint created and updated by the control to match the ramp rate set by the user. However, it will revert to show the set point value as soon as the up or down key is touched for adjustment. The ramping value is initiated to process value either on power-up or when RR and/or the set point are changed. Setting RR to zero means no ramp function.

PV Shift

In certain applications it is desirable to shift the controller display value (PV) from its actual value. This can easily be accomplished by using the PV shift function.

The SHIF function will alter PV only.

Example: A process is equipped with a heater, a sensor, and a subject to be warmed up. Due to the design and position of the components in the system, the sensor could not be placed any closer to the part. Thermal gradient (differing temperatures) is common and necessary to an extent in any thermal system for heat to be transferred from one point to another. If the difference between the sensor and the subject is 35°C, and the desired temperature at the subject to be heated is 200°C, the temperature at the sensor should be 235°C. You should enter -35°C to subtract 35°C from the actual process display. This in turn will cause the controller to energize the load and bring the process display up to the set point value.

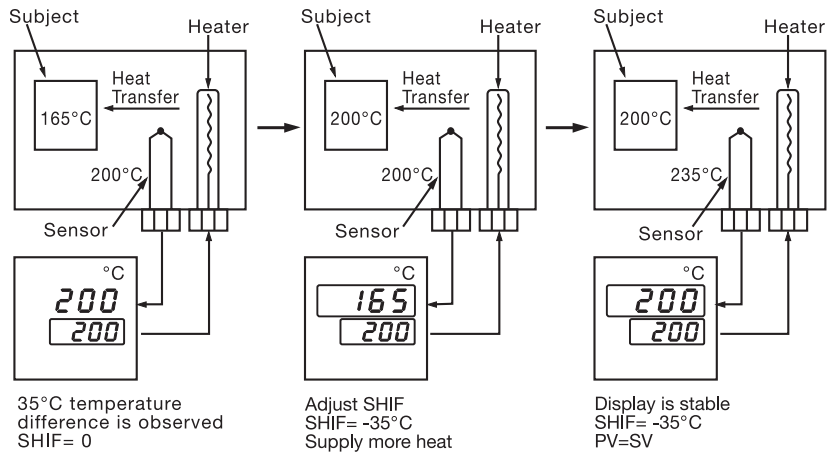

Figure 3.7 PV Shift Application

Failure Transfer

The controller will enter failure mode if one of the following conditions occurs:

1. **SBER** occurs due to input sensor break or input current below 1mA if 4–20 mA is selected or input voltage below 0.25V if 1–5V is selected.
2. **ADER** occurs due to the A-D converter of the controller failing.

Output 1 and output 2 will perform the failure transfer function as the controller enters failure mode.

Output 1 failure transfer, if activated, will perform:

1. If output 1 is configured as proportional control ($PB \neq 0$), and BPLS is selected for O1FT, then output 1 will perform bumpless transfer. Thereafter, the previous averaging value of MV1 will be used for controlling output 1.
2. If output 1 is configured as proportional control ($PB \neq 0$), and a value of 0 to 100.0% is set for O1FT, then output 1 will perform failure transfer. Thereafter, the value of O1FT will be used for controlling output 1.

3. If output 1 is configured as ON-OFF control ($PB=0$), then output 1 will be driven OFF if OFF is set for O1FT and will be driven ON if ON is set for O1FT.

Manual Control

Operation

To enable manual control, the LOCK parameter should be set to NONE, then press \square for 6.2 seconds; $\overline{H} \overline{H} \overline{H} \overline{H}$ $\square \square \square \square$ (hand control) will appear on the display. Press \square for 5 seconds, then the MAN indicator will begin to flash and the lower display will show $\overline{H} \square \square \square$. The controller is now in manual control mode. $\overline{H} \square \square \square$ indicates output control variable for output 1, and $\overline{L} \square \square \square$ indicates control variable for output 2. Now you can use the up and down keys to adjust the percentage values for the heating or cooling output.

The controller performs open loop control as long as it stays in manual control mode.

Exit Manual Control

Pressing the \overline{R} key will cause the controller to revert to its normal display mode.

Auto-tuning

⚠ The auto-tuning process is performed near the set point. The process will oscillate around the set point during the tuning process. Set the set point at a lower value if overshooting beyond the normal process value is likely to cause damage.

Auto-tuning is applied in cases of:

- Initial setup for a new process
- The set point is changed substantially from the previous auto-tuning value
- The control result is unsatisfactory

Operation:

1. The system has been installed normally.
2. Set the correct values for the setup menu of the unit, but don't set a zero value for PB and TI, or the auto-tuning program will be disabled. The LOCK parameter should be set at NONE.
3. Set the set point to a normal operating value, or a lower value if overshooting beyond the normal process value is likely to cause damage.
4. Press **↻** and hold until **AT** appears on the display.
5. Then press **↻** again for at least 5 seconds. The AT indicator will begin to flash and the auto-tuning procedure begins.

NOTE: The ramping function, if used, will be disabled when auto-tuning is taking place.

Auto-tuning mode is disabled as soon as either failure mode or manual control mode is entered.

Procedures:

Auto-tuning can be applied either as the process is warming up (cold start), or when the process has been in a steady state (warm start). After the auto-tuning procedures are completed, the AT indicator will cease to flash and the unit will revert to PID control using its new PID values. The PID values obtained are stored in the nonvolatile memory.

ATER Auto-Tuning Error

If auto-tuning fails an ATER message will appear on the upper display in the following cases:

- If PB exceeds 9000 (9000 PU, 900.0°F or 500.0°C),
- if TI exceeds 1000 seconds,
- if the set point is changed during the auto-tuning procedure.

Solutions to **ATER**

1. Try auto-tuning once again.
2. Don't change the set point value during the auto-tuning procedure.
3. Don't set a zero value for PB and TI.
4. Use manual tuning instead of auto-tuning (see section 3-12).
5. Touch RESET key to reset **ATER** message.

Manual Tuning

In certain applications auto-tuning may be inadequate for the control requirements. You can try manual tuning for these applications.

If the control performance using auto-tuning is still unsatisfactory, the following rules can be applied for further adjustment of PID values:

ADJUSTMENT SEQUENCE	SYMPTOM	SOLUTION
(1) Proportional Band (PB)	Slow Response	Decrease PB
	High overshoot or Oscillations	Increase PB
(2) Integral Time (TI)	Slow Response	Decrease TI
	Instability or Oscillations	Increase TI
(3) Derivative Time (TD)	Slow Response or Oscillations	Decrease TD
	High Overshoot	Increase TD

Table 3.2 PID Adjustment Guide

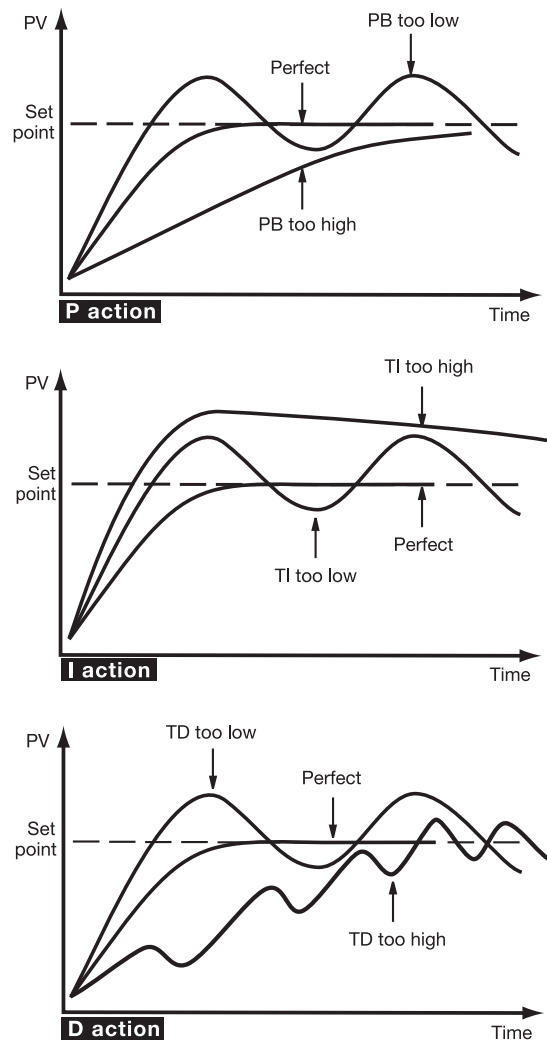

Figure 3.9 Effects of PID Adjustment

Figure 3.9 shows the effects of PID adjustment on process response.

Table A.1 Error Codes and Corrective Actions

Error Code	Display Symbol	Error Description	Corrective Action
4	<i>Er 04</i>	Illegal setup values being used: Before COOL is used for OUT2, DIRT (cooling action) has already been used for OUT1, or PID mode is not used for OUT1 (that is, PB=0 and/or TI=0)	Check and correct setup values of OUT2, PB, TI and OUT1. If OUT2 is required for cooling control, the control should use PID mode (PB≠0, TI≠0) and OUT1 should use reverse mode (heating action). Otherwise, don't use OUT2 for cooling control.
10	<i>Er 10</i>	Communication error: bad function code	Correct the communication software to meet the protocol requirements.
11	<i>Er 11</i>	Communication error: register address out of range	Don't issue an over-range register address to the slave.
14	<i>Er 14</i>	Communication error: attempt to write a read-only data or a protected data	Don't write a read-only data or a protected data to the slave.
15	<i>Er 15</i>	Communication error: write a value which is out of range to a register	Don't write an over-range data to the slave register.
26	<i>ALEr</i>	Fail to perform auto-tuning function	<ol style="list-style-type: none"> 1.The PID values obtained after auto-tuning procedure are out of range. Retry auto-tuning. 2.Don't change set point value during auto-tuning procedure. 3.Use manual tuning instead of auto-tuning. 4. Don't set a zero value for PB. 5. Don't set a zero value for TI. 6. Press RESET key
29	<i>EEPE</i>	EEPROM can't be written correctly	Return to factory for repair.
30	<i>CJEr</i>	Cold junction compensation for thermocouple malfunction	Return to factory for repair.
39	<i>SbEr</i>	Input sensor break, or input current below 1 mA if 4-20 mA is selected, or input voltage below 0.25V if 1-5V is selected	Replace input sensor.
40	<i>ADEr</i>	A to D converter or related component(s) malfunction	Return to factory for repair.

RETURNS

No product returns can be accepted without a completed Return Material Authorization (RMA) form.

TECHNICAL SUPPORT

Technical questions and troubleshooting help is available from Tempco. When calling or writing please give as much background information on the application or process as possible.

E-mail: techsupport@tempco.com

Phone: 630-350-2252
800-323-6859

Common Causes of Failures

- Incorrect parameters entered in menu (most common)
- Excessive electrical interference
- Line wires are improperly connected
- No voltage between line terminals
- Incorrect voltage between line terminals
- Connections to terminals are open, missing or loose
- Thermocouple (or RTD) is open at tip
- Thermocouple (or RTD) is broken
- Shorted thermocouple (or RTD) leads
- Short across terminals
- Open or shorted heater circuit
- Open coil in external contactor
- Burned out line fuses
- Defective solid-state relays
- Defective line switches
- Burned out contactor
- Defective circuit breakers

If the points listed above have been checked and the controller does not function, it is suggested that the instrument be returned for inspection.

Please request an RMA (Return Material Authorization) number for return instructions.

NOTES

Custom Manufacturer Since 1972

ELECTRIC HEATING ELEMENTS • TEMPERATURE CONTROLS • SENSORS • PROCESS HEATING SYSTEMS

HEAT THINGS UP!

With Thousands of Design Variations
We Make Everything You Need.

Band Heaters	Cartridge Heaters
Cast-In Heaters	Coil & Cable Heaters
Radiant Heaters	Strip Heaters
Flexible Heaters	Tubular Heaters
Process Heaters	Instrumentation
Temperature Control	Temperature Sensors



607 N. Central Avenue Wood Dale, IL 60191-1452 USA
P: 630-350-2252 Toll Free: 800-323-6859
F: 630-350-0232 E: info@tempco.com
www.tempco.com