

Instructions for Tempco Control Enclosure PCM10076 through PCM10079

Temperature Controller: Model TEC-9400, 1/16 DIN, Dual Display with PID Auto-tuning

Part Number	Input Voltage (50/60 Hz)	Max. Amperage	Heater Fusing	Maximum Wattage	Thermocouple Sensor Input
PCM10076	120VAC	16	20amps	1920	Type J
PCM10077	240VAC	16	20amps	3840	Type J
PCM10078	120VAC	16	20amps	1920	Type K
PCM10079	240VAC	16	20amps	3840	Type K

- 1: TEC-9400 Controller
- 2: On-Off Switch
- 3: 1 Amp Control Fuse (240V model has 2)
- 4: 20 Amp Main Fuse (240V model has 2)
- 5: 120V or 240V Power Cord (20A)
- 6: 120V or 240V Heater Receptacle (20A)
- 7: Type J or K Thermocouple Jack - Black= J, Yellow= K

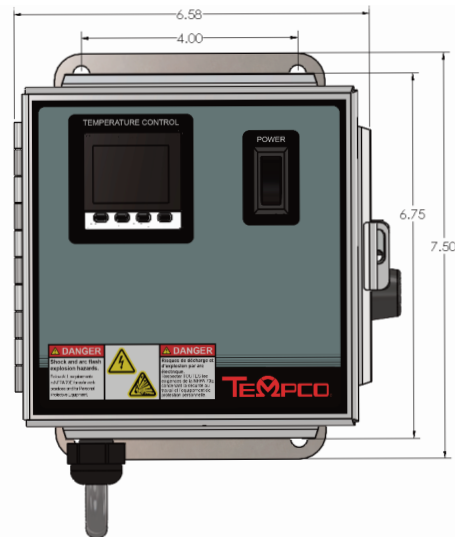
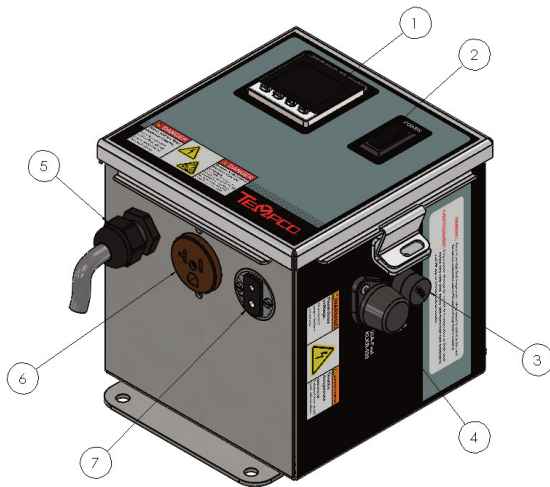

WARNINGS

1. Dangerous voltage capable of causing injury or death is present within this enclosure. Power to all equipment must be disconnected before installation or beginning any troubleshooting procedures. **All wiring and component replacement must be made by qualified personnel only.**
2. To minimize the possibility of fire or shock, do not expose this console to rain or excessive moisture.
3. Do not use this enclosure in areas where hazardous conditions exist such as excessive shock, vibration, dirt, corrosive gases, oil or where explosive gases or vapors are present.

WARNING!

Failure of devices such as the thermocouple/RTD sensor, heater output relay or temperature control may result in severe damage to a product while in process, melting of the heater or a damaging fire. A latching over-temperature protection device such as a Tempco model TEC-910 or TEC-410 high-limit controller with manual reset must be installed in your process. This device should remove power th the heating circuit if the above failure occurs. We recommend this device be classified as a safety control and carry FM. UL/CSA listing or certification. Failure to install high-limit protection where a potential hazard exists could result in damage to equipment, property and possible sever injury to personnel.

WIRING (for safety, unplug unit prior to making any heater or sensor connections)

1. Attach the leads from your thermocouple to the provided standard thermocouple jack of the same thermocouple type. **Note the correct polarity:** For type “J” and “K thermocouples, the **RED** lead is (-) negative.
2. The heater output current is sourced directly through the line cord. The bottom console output receptacle provides live controlled power for direct connection to your heater(s).

OPERATION

1. Verify the power switch is in the off position. Plug your heater into the straight-blade enclosure connector. Plug the provided line cord from the console into a standard outlet. Switch on the enclosure.
2. Using the up & down pushbuttons on the TEC-9400 controller, start out with the temperature set low to test your system. If the setpoint temperature is being maintained, set your desired temperature setpoint.

Note: The signal of the output circuit is wired through output 2 of the TEC-9400 which can be used as a cut-out in the event of an over-setpoint temperature condition. This is a deviation contact set to 30° F above the setpoint.

In the event of an over-setpoint temperature condition, output 2 will open, cutting the control signal to the output relay.

This deviation setpoint can be changed by accessing “A1SP” in the TEC-9400 (note page 5 for alarm menu selection). This is not meant to be a redundant safety controller. Refer to our TEC-910 for a safety controller.

3. Auto-tuning is recommended for initial set-up. Refer to page 2 of the attached manual for auto-tuning procedures.

SPARE/REPLACEMENT PARTS

Part Number	Description
EHD-124-245	(1 or 2) Main fuse(s) rated 20 amps, 250V, Class CC, fast acting, Littelfuse KLKR020 or equivalent.
EHD-124-276	Control fuse (1) rated 1 amp, 250V, 1/4 x 1¼", fast acting, Bussmann ABC-1-R or equivalent.
EHD-102-140	Output plug — 20A 125V, 2-pole, 3-wire grounding, NEMA 5-20R (PCM10076, PCM10078)
EHD-102-187	Output plug — 20A 250V, 2-pole, 3-wire grounding, NEMA 6-20P (PCM10077, PCM10079)
TCA-101-101	Thermocouple plug, Type “J” (if PCM10076, PCM10077)

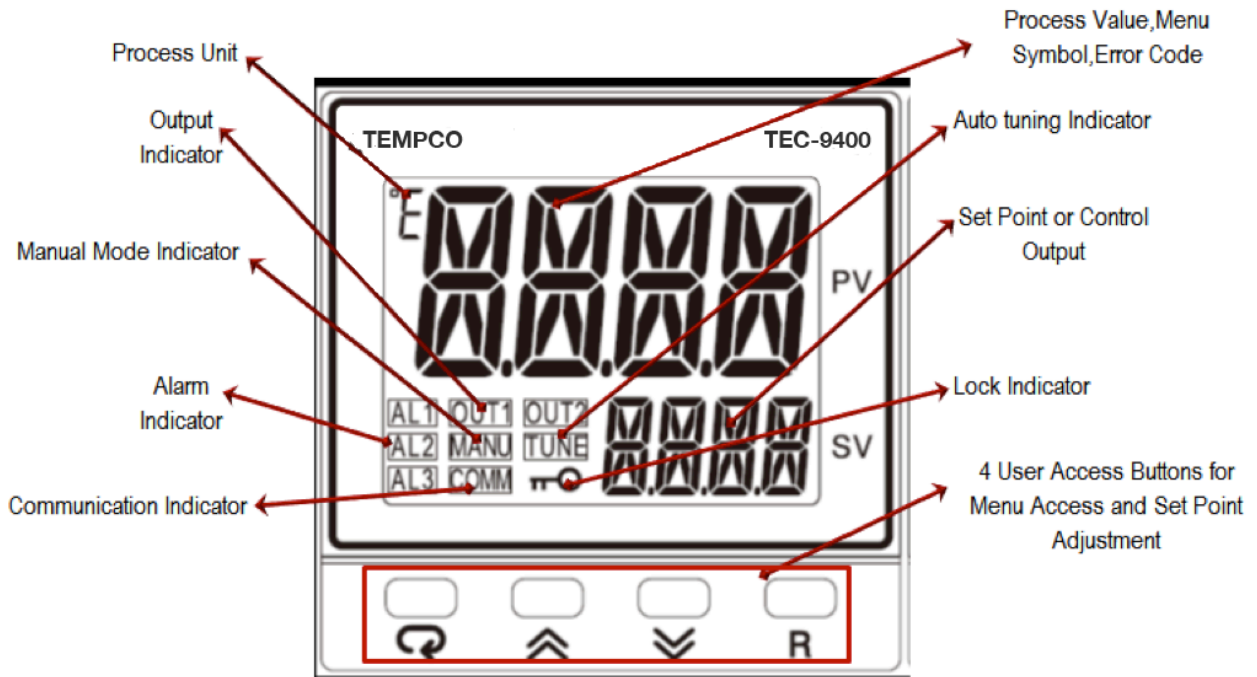

TEC-9400 Front Panel Keys and Display

KEYPAD OPERATION

SCROLL KEY:

This key is used to scroll through a menu to select a parameter to be viewed or adjusted.

UP KEY:

This key is used to increase the value of the selected parameter.

DOWN KEY:







This key is used to decrease the value of the selected parameter.

RESET KEY:

This key is used to:

1. Revert the display to the home screen.
2. Reset a latching alarm once the alarm condition is removed.
3. Stop manual control mode, Auto-Tuning mode or calibration mode.
4. Clear an Auto-Tuning or communication error message.
5. Restart the dwell timer when the dwell timer has timed out.
6. Enter the manual control menu if failure mode occurs.

ENTER KEY: Press  and hold for 5 seconds or longer to:

1. Enter the setup menu. The display will show .
2. Enter manual control mode. Press and hold  for 6.2 seconds, then let go, to select manual control mode. The display will show .
3. Enter Auto-Tuning mode. Press and hold  for 7.4 seconds, then let go to select Auto-Tuning mode. The display will show .
4. Perform calibration of a selected parameter during the calibration procedure. Press and hold  for 8.6 seconds, then let go to select calibration mode.

During power-up, the upper display will show PROG and the lower display will show the Firmware version for 6 seconds.

1.1 Menu Flowchart

The Menu has been divided in to 5 groups. They are as follows:

1. User Menu - Below
2. Setup Menu - Page 5
3. Manual Mode Menu - Page 8
4. Auto-Tuning Mode Menu - Page 8
5. Calibration Mode Menu (not recommended, calibration section has been removed)

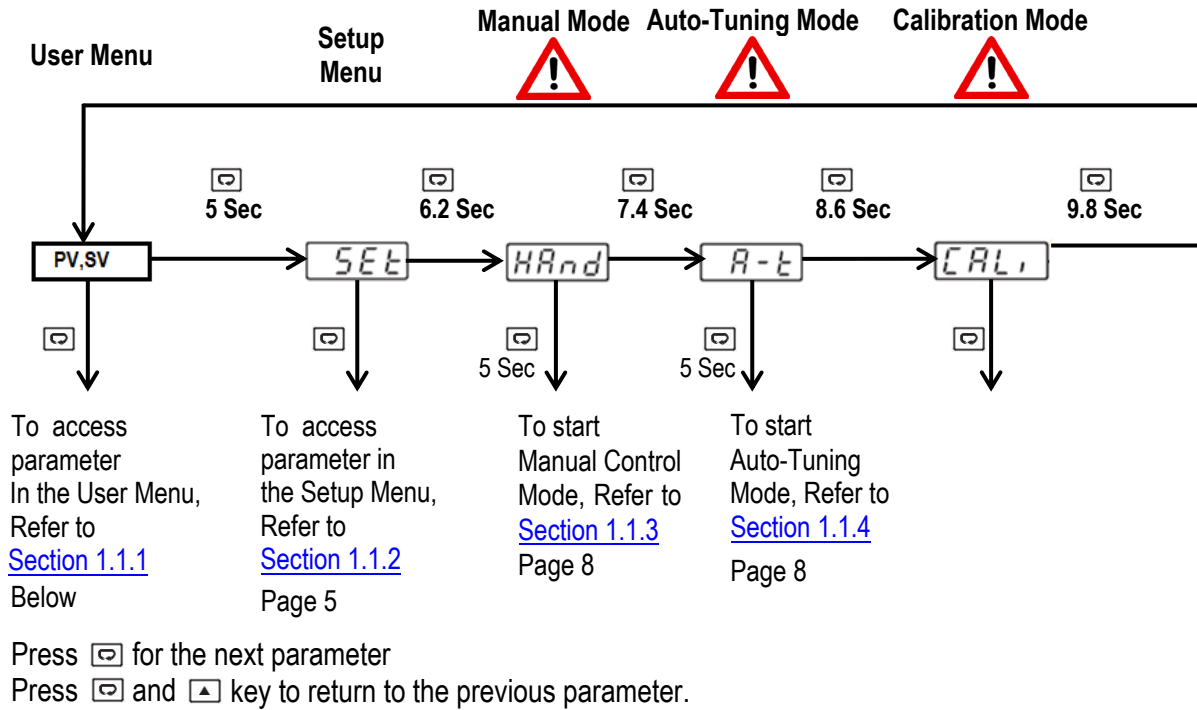

1.1.1 User Menu

The below user menu parameters are available depending on user selection.

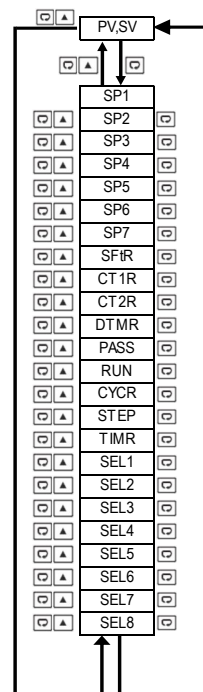



1.1.2 Setup Menu

The setup menu has been categorized in to eight categories. They are listed below.

1. Basic Menu
2. Output Menu
3. Alarm Menu
- * 4. Event Input Menu
- * 5. User Select Menu
- * 6. Communication Menu
- * 7. Current Transformer Input Menu
- * 8. Profile Menu

1.1.2.1 Basic Menu (bASE)

Use  or  key to get bASE in the lower display, then use the  key to enter to basic menu parameters (Note page 8).

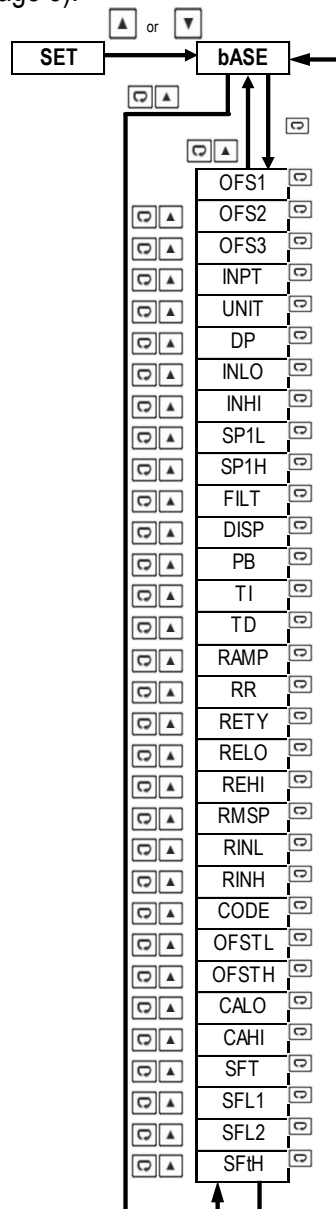

* Does not apply to the controller used in this enclosure

1.1.2.2 Output Menu (oUT)

Use ▲ or ▼ key to get oUT in the lower display, then use the ◀ key to scroll through output menu parameters. (Note pg. 10)

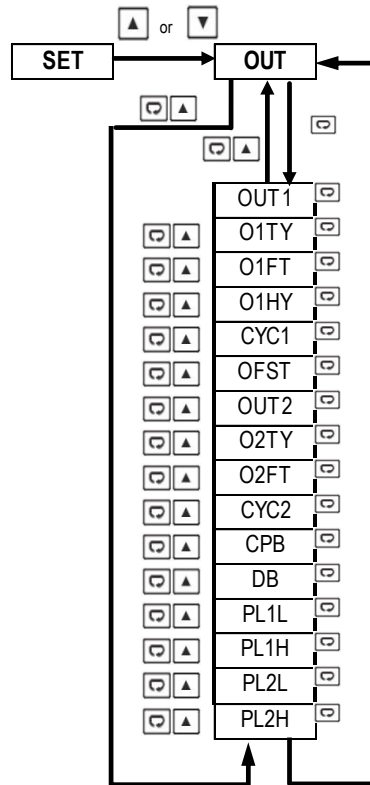

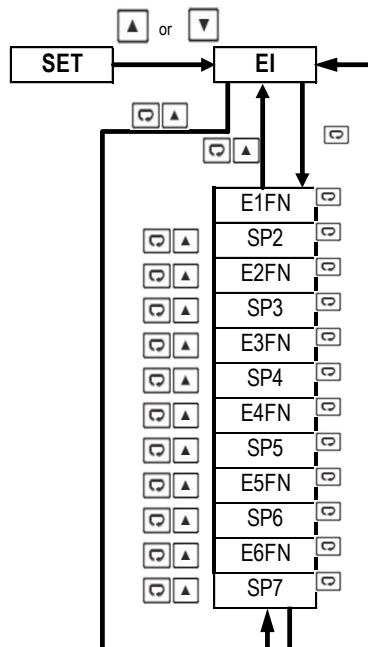

1.1.2.3 Event Input Menu (EI) (Does not apply for this unit)

Use ▲ or ▼ key to get EI in the lower display, then use the ◀ key to scroll through event input menu parameters.



1.1.2.4 Alarm Menu (ALRM)

Use  or  key to get ALRM in the lower display, then use the  key to scroll through alarm menu parameters. (Note chart on pg. 11)

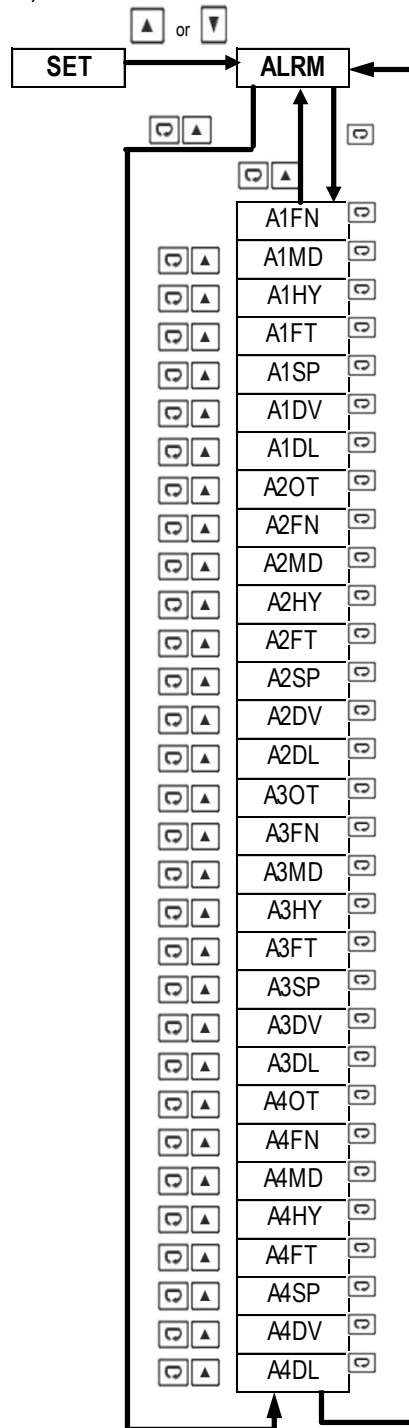

1.1.3 Manual Mode Menu – (Use for Temporary Operation if Sensor Fails) (Also refer to pg. 21)

Press and hold the “☐” key for approx. 6sec until the “HAND” parameter is shown in the upper display. Then, press and hold the “☐” key for an additional 5 sec. until an “MANU” led starts to flash in the lower left of the display. Then, use the “☐” key to cycle through the available options.

User is able to manually set the out output to be energized from 0-100% of the cycle time.

“Hx.xx” is used to adjust output 1.

“Cx.xx” is used to adjust output 2.

You are able to exit manual mode by pressing and holding the **R** key.

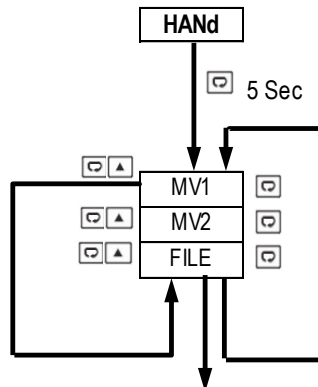

Press ☐ key 5 Sec To execute the selected default program

1.1.4 Auto-Tuning Mode – (Tunes PID Parameters to Your Application) (Also refer to pg. 19)

A-t

Press and hold the “☐” key for approx. 7sec until the “A-T” parameter is shown in the upper display.

Press and hold the “☐” key for 5 seconds to activate Auto-Tuning Mode. Continue to hold the “☐” key for an additional 3 seconds, else the display will revert to a “User Menu” parameter.

Auto-tuning allows the controller to find its own optimal control parameters (PID) by measuring the speed of your thermal process.

1.2 Parameter Description

(*Parameters that are not applicable are not shown)

Register Address	Parameter Notation	Parameter Description	Range	Default Value
0	SP1	Set Point 1 (Used for Output 1)	Low: SP1L High: SP1H	77.0 °F (25.0 °C)
8	INPT	Input sensor selection (See pg. 12)	0 J_tC: J type Thermocouple 1 K_tC: K type Thermocouple	0 or 1 (Depends on Model Ordered)
9	UNIT	Input unit selection	0 oC: °C unit 1 oF: °F unit 2 Pu: Process unit	1
10	DP	Decimal point selection	0 No.dP: No decimal point 1 1.dP: 1 decimal digit 2 2.dP: 2 decimal digit 3 3.dP: 3 decimal digit	0
13	SP1L	Low limit of set point 1 (Span Value)	Low: -19999 High :SP1H	0.0 °F (-18.0 °C)
14	SP1H	High limit of set point 1 (Span Value)	Low: SP1L High: 45536	1000.0 °F (538.0 °C)
15	FILT	Filter damping time constant of PV Sensor	0 0: 0 second time constant 1 0.2: 0.2 second time constant 2 0.5: 0.5 second time constant 3 1: 1 second time constant 4 2: 2 second time constant 5 5: 5 second time constant 6 10: 10 second time constant 7 20: 20 second time constant 8 30: 30 second time constant 9 60: 60 second time constant	2
16	DISP	Secondary display selection	0 None: No Display 1 MV1: Display MV1 2 MV2: Display MV2 3 tIMR: Display Dwell Time 4 PRoF: display Profile Status	0
17	PB	Proportional band value (See pg. 20)	Low: 0.0 High: 900.0°F (500.0°C)	18.0 °F (10.0 °C)
18	TI	Integral time value (See pg. 20)	Low: 0 High: 3600 sec	100

Basic Menu

(*Parameters that are not applicable are not shown)

Register Address	Parameter Notation	Parameter Description	Range	Default Value
19	TD	Derivative time value	Low: 0.0 High: 360.0 sec	25
20	OUT1	Output 1 function	0 REVR : Reverse (heating) control action 1 DIRt : Direct (cooling) control action	0
21	O1TY FACTORY SET, DO NOT CHANGE	Output 1 signal type	0 RELY : Relay output 1 SSrd : Solid state relay drive output 2 4-20 : 4-20mA linear current 3 0-20 : 0-20mA linear current 4 0-5V : 0-5VDC linear voltage 5 1-5V : 1-5VDC linear voltage 6 0-10 : 0-10VDC linear voltage	0
22	O1FT	Output 1 failure transfer mode (See Pg. 18)	Select BPLS (Bumpless transfer), or 0.0 ~ 100.0 % to continue output 1 control function if the sensor fails, or select OFF (0) or ON (1) for ON-OFF control	0
23	O1HY	Output 1 ON-OFF control hysteresis. PB=0	Low: 0.2°F (0.1°C) High: 90.0°F (50.0°C)	0.2 °F (0.1 °C)
24	CYC1	Output 1 cycle time	Low: 0.1 High: 90.0 sec.	18.0
26	RAMP	Ramp function selection (See Pg. 16)	0 NoNE : No Ramp Function 1 MINR : Use %/minute as Ramp Rate 2 HRR : Use %/hour as Ramp Rate	0
27	RR	Ramp rate (See Pg. 16)	Low: 0.0 High: 900.0°F	0

Basic Menu

Output Menu

Basic Menu

(*Parameters that are not applicable are not shown)



Register Address	Parameter Notation	Parameter Description	Range	Default Value
34	A1FN	Alarm 1 function for alarm 1 output (See pg. 14)	0 <i>NoNE</i> : No alarm function 1 <i>dtMR</i> : Dwell timer action 2 <i>dE.HI</i> : Deviation high alarm 3 <i>dE.Lo</i> : Deviation low alarm 4 <i>db.HI</i> : Deviation band out of band alarm 5 <i>db.Lo</i> : Deviation band in band alarm 6 <i>PV.HI</i> : Process value high alarm 7 <i>PV.Lo</i> : Process value low alarm 8 <i>H.bK</i> : Heater break alarm 9 <i>H.St</i> : Heater short alarm	3
35	A1MD	Alarm 1 operation mode	0 <i>NoRM</i> : Normal alarm action 1 <i>LtCH</i> : Latching alarm action 2 <i>HoLd</i> : Hold alarm action 3 <i>Lt.Ho</i> : Latching & Hold action 4 <i>SP.Ho</i> : Set point holding alarm	0
36	A1HY	Hysteresis control of alarm1	Low: 0.2°F (0.1°C) High: 90.0°F (50.0°C)	0.2 °F (0.1 °C)
37	A1FT	Alarm 1 failure transfer mode	0 <i>OFF</i> : Alarm output OFF if sensor fails 1 <i>ON</i> : Alarm output ON if sensor fails	1
38	A1SP	Alarm 1 set point	Low: -19999 High: 45536	30 °F (-1.0 °C)
39	A1DV	Alarm 1 deviation value	Low: -19999 High: 45536	18.0 °F (10.0°C)
61	PL1L	Output 1 Low Power limit	Low: 0 High: PL1H or 50%	0
62	PL1H	Output 1 High Power limit	Low: PL1L High: 100 %	100
94	PASS	Password entry (See Next Page)	Low: 0 High: 9999	0

Alarm Menu

Output Menu

User Menu

2 Programming

Press and hold the  key for 5 seconds, then release to enter the setup menu. Press and release the  key to select the desired parameter. The upper display indicates the parameter symbol, and the lower display indicates the value of the selected parameter.

2.1 User Security

There are two parameters, PASS (password) and CODE (security code), which will control the security function.

CODE Value	PASS Value	Access Rights
0	Any Value	All parameters are changeable
1000	=1000	All parameters are changeable
	≠1000	Only user menu parameters changeable
9999	=9999	All parameters are changeable
	≠9999	Only SP1 to SP7 are changeable
Others	=CODE	All parameters are changeable
	≠CODE	No parameters can be changed

2.2 Signal Input

INPT: Select the sensor or signal type for the desired signal input

Range: (Thermocouple) J_TC, K_TC.

UNIT: Select the process unit

Range: °C, °F, PU (Process unit). If the unit is neither °C nor °F, select

PU. **DP:** Select the resolution of process value.

Range: For Thermocouple and RTD Signal NO.DP, 1-DP.

2.3 Control Output

There are 4 kinds of control modes that can be configured as shown below.

Control Mode	OUT 1	OUT 2	O1HY	O2HY	CPB	DB
Heat Only	REVR	X	Δ	X	X	X
Cool Only	DIRT	X	Δ	X	X	X
Heat PID Cool ON-OFF	REVR	DE.HI	X	O	X	X
Heat PID Cool PID	REVR	COOL	X	X	O	O

X: Not applicable

O: Adjust to meet process Requirements

Δ: Required if ON-OFF Control is configured

2.3.1 Heat Only ON-OFF Control

Select REVR for OUT1, Set PB to 0. O1HY is used to adjust the dead band for ON-OFF control. The output 1 hysteresis (O1HY) setting becomes available when PB = 0. The heat only ON-OFF control function is shown on the following page.

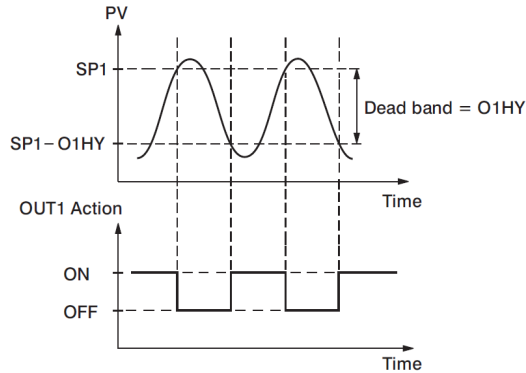

ON-OFF control may cause excessive process oscillations even if the hysteresis is set to the smallest value. If ON-OFF control is set (i.e. PB = 0), TI, TD, CYC1, OFST, CYC2, CPB, DB will no longer be applicable and will be hidden. Auto-Tuning and Bumpless transfer will also be unavailable.

2.3.2 Heat only P or PD Control

Select REVR for OUT1, set TI = 0, OFST is used to adjust the control offset (manual reset). If PB ≠ 0 then O1HY will be hidden.

OFST Function: OFST is measured in % with a range of 0 - 100.0 %. When the process is stable, let's say the process value is lower than the set point by 5°C. Let's also say that 20 is used for the PB setting. In this example, 5°C is 25% of the proportional band (PB).

By increasing the OFST value by 25%, the control output will adjust itself, and the process value will eventually coincide with the set point.

When using Proportional (P) control (TI = 0), Auto-Tuning will be unavailable. Refer to "manual tuning" section for the adjustment of PB and TD. Manual reset (OFST) is usually not practical because the load may change from time to time; meaning the OFST setting would need to be constantly adjusted. PID control can avoid this problem.

2.3.3 Heat only PID Control

Select REVR for OUT1. PB and TI should not be zero. Perform Auto-Tuning for initial startup, or set PB, TI and TD using historical values. If the control result is not satisfactory, use manual or Auto-Tuning to improve the control performance. The unit contains a PID and Fuzzy algorithm to achieve the set point with a very small overshoot and very quick response to the process if it is properly tuned.

2.3.4 Cool only Control

ON-OFF control, P (PD) control and PID control can be used for cooling control. Set OUT1 to DIRT (direct action). The other functions for cooling only are ON-OFF control, cool only P (PD) control and cool only PID control are same as for heating, except that the output variable (and action) is reversed.

NOTE: ON-OFF control may result in excessive overshoot and undershoot problems in the process. P (or PD) control will result in a deviation of the process value from the set point. It is recommended to use PID control for Heat-Cool control when able to produce a stable and zero offset process value

2.3.5 Output 2 ON-OFF Control (Alarm function)

Output 2 can also be configured as an alarm output. There are 7 kinds of alarm functions and a Dwell timer (dtMR) that can be selected for output 2. The output options are:

- dtMR (Dwell Timer)
- dE.HI (deviation high alarm)
- dE.Lo (deviation low alarm)
- dB.Hi (Out of band alarm)
- dB.Lo (In band Alarm)
- PV.HI (process value high alarm)
- PV.LO (process value low alarm)

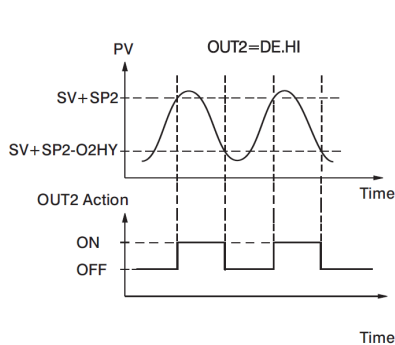

Output 2 Deviation High Alarm

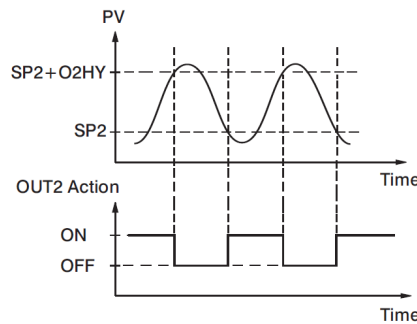

Output 2 Process Low Alarm

2.4 Alarm

The controller has up to four alarm outputs depending on the controller model. There are 11 types of alarm functions and one dwell timer that can be selected. There are 4 kinds of alarm modes (A1MD, A2MD, A3MD, and A4MD) available for each alarm function (A1FN, A2FN, A3FN, and A4FN). In addition to the alarm output, output 2 can also be configured as an alarm. But output 2 has only 8 different alarm functions or dwell timer available.

The Alarm outputs can be controlled by Event input1 and Event input 2 by selecting **Event Input 1 Control Alarm Output (E1.C.o.)** and **Event Input 2 Control Alarm Output (E2.C.o.)** for alarm function A2FN and A3FN .The output will be ON as long as the event input is ON. The output will goes OFF when the input is OFF.

2.4.1 Alarm Modes

There are five types of alarm modes available for each alarm function.

1. Normal alarm
2. Latching alarm
3. Holding alarm
4. Latching/ Holding alarm
5. Set point Holding Alarm

2.4.1.1 Normal Alarm: *ALMD = NORM*

When a normal alarm is selected, the alarm output is de-energized in the non-alarm condition and energized in an alarm condition.

2.4.1.2 Latching Alarm: *ALMD = LTCH*

If a latching alarm is selected, once the alarm output is energized, it will remain unchanged even if the alarm condition is cleared. The latching alarm can be reset by pressing the RESET key once the alarm condition is removed.

2.4.1.3 Holding Alarm: *ALMD = HOLD*

A holding alarm prevents an alarm condition during power up. This will ignore the alarm condition at first time after power on. Afterwards, the alarm performs the same function as normal alarm.

2.4.1.4 Latching / Holding Alarm: *ALMD = LT.HO*

A latching / holding alarm performs both holding and latching functions. The latching alarm is reset when the RESET key is pressed after the alarm condition is removed.

2.4.1.5 Set Point Holding Alarm: *ALMD = SP.HO*

A set point holding alarm prevents an alarm from power up and / or changing set point. The alarm output is de-energized whenever the set point is changed even if it is in an alarm condition. The alarm reverts to a normal alarm once the alarm condition is removed.

2.4.4 Alarm Delay

In certain applications during startup, nuisance alarms will be generated before the process value reaches the set point. To avoid these kinds of nuisance alarms, a time delay for alarms is available. To enable the time delay for alarms, set the delay time using the A1DL, A2DL, A3DL, and A4DL parameters. These parameters will avoid the nuisance alarm during the process value reaches set point.

2.5 Ramp

The ramping function is performed during power up or any time the set point is changed. Choose “MINR” (ramp in minutes) or “HRR” (ramp in hours) for the “RAMP” setting, and the controller will perform the ramping function. The ramp rate is programmed by adjusting the “RR” setting. The ramping function is disabled whenever the controller enters Failure mode, Manual control mode, Auto-Tuning mode or Calibration mode.

2.5.1 Ramping Example without Dwell Timer

Set the “RAMP” setting to “MINR” to ramp in minutes.

Set the ramp rate (RR) to 10.

The starting temperature is 30°C.

The setpoint is initially set to 200°C.

After the process warms up, the user changed the setpoint to 100°C after 30 minutes.

After power up, the process will behave as shown below.

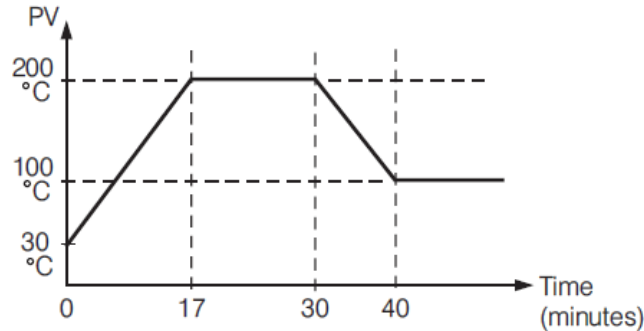

3-6.Ramp Function

Note: When the ramp function is used, the lower display will show the current ramping value. However it will revert to show the set point value as soon as the up or down key is touched for adjustment. The ramp rate is initiated at power on and/or whenever the Set point is changed. Setting the “RR” setting to zero means no ramping function is used.

The **Dwell timer** can be used separately or accompanied with a Ramp. Alarm outputs can be configured as dwell timers by selecting “dtMR” for A1FN. If A1FN is set to “dtMR”, Alarm 1 will act as a dwell timer. Similarly, Alarm 2, Alarm3, or Alarm4 will act as dwell timers if A2FN, A3FN, or A4FN is set to “dtMR”. When the dwell timer is configured, the parameter “dtMR” is used for dwell time adjustment.

A deviation alarm energizes when the process value deviates too far from the set point.

- When the process value is higher than $SV+A1DV$, a **deviation high alarm (dE.HI)** occurs. The alarm is off when the process value is lower than $SV+A1DV-A1HY$.
- When the process value is lower than $SV+A1DV$, a **deviation low alarm (dE.Lo)** occurs. The alarm is off when the process value is higher than $SV+A1DV+A1HY$.

The trigger level of a deviation alarm moves with the set point.

A deviation band alarm presets two trigger levels centered on the set point.

The two trigger levels are $SV+A1DV$ and $SV-A1DV$. When the process value is higher than $(SV+A1DV)$ or lower than $(SV - A1DV)$, a **deviation band high alarm (dB.HI)** occurs. When the process value is within the trigger levels, a **deviation band low alarm (dB.Lo)** occurs.

In the above descriptions, SV denotes the current set point value for control.

A process alarm can set two absolute trigger levels. When the process value is higher than A1SP, a **process high alarm (PV.HI)** occurs. The alarm is off when the process value is lower than $A1SP-A1HY$. When the process value is lower than A1SP, a **process low alarm (PV.Lo)** occurs. The alarm is off when the process is higher than $A1SP+A1HY$. A process alarm is independent of the set point.

In the above description, A1SP and A1HY denote the Alarm1 Set point and Alarm1 Hysteresis. The respective Set point and Hysteresis parameters need to be set for other Alarm outputs.

For example, the process set point set to 100. As the process approaches 100, it may oscillate between 103 and 97. During this time the Hi Alarm will be activated and deactivated continuously. To avoid these kind of nuisance alarms, the alarm delay function can be used. It will generate the alarm after the PV is in an alarm condition continuously a preconfigured period of time in the alarm delay parameters. The alarm delay can be configured in minutes and seconds.

2.5.2 Alarm Failure Transfer

Alarm Failure transfer is activated as the unit enters failure mode. The respective Alarm will go on if ON is set for A1FT, A2FT, A3FT or A4FT and will go off if OFF is set for A1FT, A2FT, A3FT, or A4FT. The unit will enter failure mode if a sensor break occurs or if the A-D converter fails.







2.6 User Calibration

Each unit is calibrated in the factory before shipment. The user can still modify the calibration in the field. The basic calibration of the controller is highly stable and set for life. User calibration allows the user to offset the permanent factory calibration in order to:

- ❖ Calibrate the controller to meet a user reference standard.
- ❖ Match the calibration of the controller to that of a particular transducer or sensor input.
- ❖ Calibrate the controller to suit the characteristics of a particular installation.
- ❖ Remove long term drift in the factory set calibration.

There are two parameters: Offset Low (OFTL) and Offset High (OFTH) for adjustment to correct an error in the process value.

There are two parameters for the sensor input. These two signal values are CALO and CAHI. The input signal low and high values are to be entered in the CALO and CAHI parameters respectively.

Refer to [section 1.1](#) for key operation and [section 1.1.5](#) for the operation flowchart. Press and hold the  key until the setup Menu page is obtained. Then, press and release the  key to navigate to the calibration low parameter OFTL. Send your low signal to the sensor input of the controller, then press and release the  key. If the process value (the upper display) is different from the input signal, the user can use  and  keys to change the OFTL value (the lower display) until the process value is equal to the value the user needs. Press and hold the  key for 5 seconds to complete the low point calibration. A similar procedure is applied for high scale calibration.

As shown below, the two points OFTL and OFTH construct a straight line. For the purpose of accuracy, it is best to calibrate with the two points as far apart as possible. After the user calibration is complete, the input type will be stored in the memory. If the input type is changed, a calibration error will occur and an error code `CAEr` is displayed.

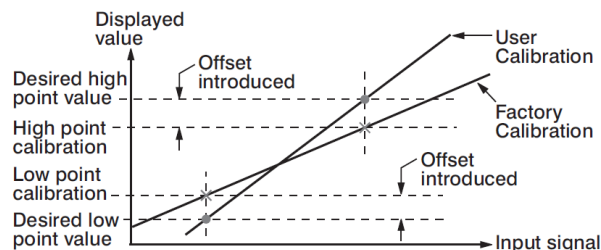

2.6.1 Digital Filter

In certain applications, the process value is too unstable to be read due to electrical noise or interference. To improve this, a programmable filter in the controller can be used by setting the "FILT" parameter. A value of 0.5 seconds is used as a factory default. Adjust FILT to change the time constant from 0 to 60 seconds. 0 seconds represents no filter applied to the input signal. The filter is characterized by the following diagram.

2.7 Failure Transfer

The controller will enter failure mode if one of the following conditions occurs.

1. An "SBER" error occurs due to an input sensor break, an input current below 1mA for 4-20mA, or an input voltage below 0.25V for 1-5V.
2. An ADER error occurs due to the A-D converter of the controller fails.
Output 1 and Output 2 will perform the failure transfer (O1.ft & O2.ft) function if the controller enters failure mode.

2.7.1 Output 1 Failure Transfer

If Output 1 Failure Transfer is activated, it will function as follows:

1. If output 1 is configured as proportional control (PB≠0), and BPLS is selected for O1FT, then output 1 will perform a Bumpless transfer. After that, the previous average value of MV1 will be used for controlling output 1.
2. If output 1 is configured as proportional control (PB≠0), and a value of 0 to 100.0 % is set for O1FT, then output 1 will perform failure transfer. After that the value of O1FT will be used for controlling output 1.
3. If output 1 is configured as ON-OFF control (PB=0), then output 1 will transfer to an off state if OFF is set for O1FT, and transfer to on state if ON is set for O1FT.



2.8 Auto-Tuning

 The Auto-Tuning process will be performed using the set point (SP1). The process will oscillate around the set point during the tuning process. Set a set point to a lower value if overshooting beyond the normal process value will cause damage. It is usually best to perform Auto-Tuning at the Set point the machine is expected to be operated at, with the process running normally (i.e. material in the oven, etc.)

Auto-Tuning is generally applied in the following cases:

- ❖ Initial setup for a new process
- ❖ The set point is changed substantially from the previous Set point when Auto-Tuning was performed.
- ❖ The control result is unsatisfactory

2.8.1 Auto-Tuning Operation Steps

1. The system is operational under “real world” conditions.
2. Do not use a zero value for PB or TI; otherwise, the Auto-Tuning program will be disabled. The “LOCK” parameter should be set to NONE.
3. Set the set point to a normal operating value or a lower value if overshooting beyond the normal process value will cause damage.
4. Press and hold the  key until R-t appears on the upper display, then let go.
5. Press and hold the  key for at least 5 seconds. The “TUNE” indicator will begin to flash, and the Auto-Tuning process will begin.

NOTE:

If the ramping function is used, it will be disabled during Auto-Tuning. The Auto-Tuning mode is disabled if either a failure mode or manual control mode occurs.

Procedures:

Auto-Tuning can be applied either as the process is warming up (Cold Start) or once the process has reached a steady state (Warm Start). After Auto-Tuning process is completed, the “TUNE” indicator will stop flashing and the controller will revert to PID control using its new PID values.

2.8.2 Auto-Tuning Error

If Auto-Tuning fails, an ATER **ATER** message will appear on the upper display in any of the following cases.

- ❖ If PB exceeds 9000 (9000 PU, 900.0°F or 500.0°C)
- ❖ If TI exceeds 1000 seconds
- ❖ If the set point is changed during the Auto-Tuning process.

2.8.3 Solutions for an Auto Tuning Error

1. Try Auto-Tuning once again.
2. Make sure not to change the setpoint or any other settings during auto-tuning.
3. Make sure PB and TI are not set to 0.
4. Use manual tuning
5. Touch RESET **R** key to reset the **ATER** message.

2.9 Manual Tuning

In certain applications, using Auto-Tuning to tune a process may be inadequate. If this is the case, the user can try manual tuning.



The following guidelines can be applied for further adjustment of PID values.

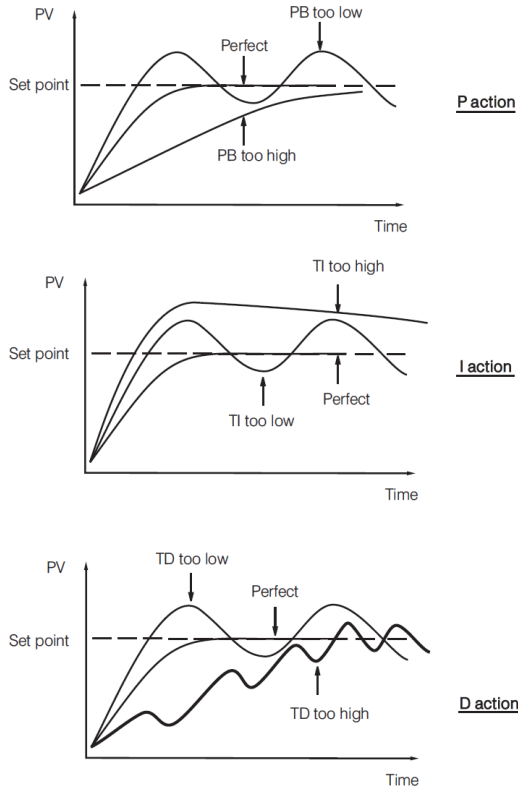

ADJUSTMENT SEQUENCE	SYMPTOM	SOLUTION
Proportional Band (PB)	Slow Response	Decrease PB
	High overshoot or Oscillations	Increase PB
Integral Time (TI)	Slow Response	Decrease TI
	Instability or Oscillations	Increase TI
Derivative Time (TD)	Slow Response or Oscillations	Decrease TD
	High Overshoot	Increase TD

Effects of PID Adjustment are as follows. Note that this is a guide only, and your specific application may be different.

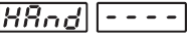

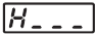

2.10 Manual Control

To enable manual control, ensure the LOCK parameter is set to NONE. Press and hold  for 6.2 seconds or until  (Hand Control) appears on the display, then let go. Press and hold  for an additional 5 seconds or until the MANU indicator begins to flash. The lower display will show .

 Indicates the output control variable for output 1, and  indicates the control variable for output 2. The user can use the up-down keys to adjust the percentage values for the heating or cooling output. This is a % value is based on the CYC1 and CYC2 settings, where the associated output will stay on for the % of time the CYC1 & CYC2 values are set for.

*The controller performs open loop control in manual control mode and does not use the sensor input to vary the control output.





The manual mode menu can also be reached by pressing   keys.

2.10.1 Exiting Manual Control

Pressing the  key will revert the controller to its normal display mode.

3 Factory Default Settings

The controller parameters can be loaded with default values listed in the parameter description table. In certain situation it is desirable to retain these values after the parameters values has been changed. The below procedure to be followed to reload the default values.

1. Ensure the LOCK parameter is set to NONE.
2. Press and hold  for 6.2 seconds or until   (Hand Control) appears on the display.
3. Press  key to navigate the manual mode menu to reach FILE.
4. Press and hold  for 5 seconds or until the upper display FILE flash for a moment.

The default values of all parameters are now loaded.

6.4 Error Code

The description of the Error code is explained below

Error Code	Display Symbol	Description & Reason	Corrective Action
4	ER04	Illegal setup values used: COOL is used for OUT2 when DIRT (cooling action) is used for OUT1, or when PID mode is not used for OUT1 (PB =0 and/or TI=0)	Check and correct setup values of OUT2, PB1, PB2, TI1, TI2 and OUT1. IF OUT2 is needed for cooling control, the controller should use PID mode (PB ≠ 0 and TI ≠ 0) and OUT1 should use reverse mode (heating action), otherwise, OUT2 cannot be used for cooling control
10	ER10	Communication error: bad function code	Correct the communication software to meet the protocol requirements.
11	ER11	Communication error: register address out of range	Do not issue an over-range address of the register to the secondary
14	ER14	Communication error: attempt to write a read-only data	Do not write read-only data or protected data to the secondary.
15	ER15	Communication error: write a value which is out of range to a register	Do not write an over-range data to the secondary register
16	EIER	Event Input Error: Two or more event inputs are set to the same function	Do not set the same function in two or more Event Input Function parameters (E1FN through E6FN)
26	ATER	Auto-Tuning Error: Failed to perform Auto-Tuning function	<ol style="list-style-type: none"> 1. The PID values obtained after Auto-Tuning process are out of range. Retry Auto-Tuning. 2. Do not change the setpoint value during Auto-Tuning process. 3. Use manual tuning instead of Auto-Tuning process. 4. Do not set a zero value for TI. 5. Do not set a zero value for PB. 6. Touch RESET key
29	EEPR	EEPROM can't be written correctly	Return to factory for repair.
30	CJER	Cold junction compensation for Thermocouple malfunction	Return to factory for repair.
39	SBER	Input sensor break, or input current below 1 mA if 4-20 mA is used, or input voltage below 0.25V if 1 - 5V is used	Replace the input sensor.
40	ADER	A to D converter or related component(s) malfunction	Return to factory for repair.

6-5.Error Code

6.5 Mode

The Value of the Mode Register is as below.

Value	Mode
H'000X	Normal mode
H'010X	Calibration mode
H'020X	Auto-Tuning mode
H'030X	Manual control mode
H'040X	Failure mode
H'0X00	Alarm status is off
H'0x01	Alarm status is on

6-6.Operation Mode

RETURNS

No product returns can be accepted without a completed Return Material Authorization (RMA) form.

TECHNICAL SUPPORT

Technical questions and troubleshooting help is available from Tempco. When calling or writing please give as much background information on the application or process as possible.

E-mail: techsupport@tempco.com

Phone: 630-350-2252

800-323-6859

Note: Information in this manual was deemed correct at the time of printing. The policy of Tempco is one of continuous development and product improvement, and we reserve the right to modify specifications and designs without prior notice. Not responsible for typographical errors.

NOTES

Custom Manufacturer Since 1972

ELECTRIC HEATING ELEMENTS • TEMPERATURE CONTROLS • SENSORS • PROCESS HEATING SYSTEMS

HEAT THINGS UP!

With Thousands of Design Variations
We Make Everything You Need.

Band Heaters	Cartridge Heaters
Cast-In Heaters	Coil & Cable Heaters
Radiant Heaters	Strip Heaters
Flexible Heaters	Tubular Heaters
Process Heaters	Instrumentation
Temperature Control	Temperature Sensors



607 N. Central Avenue Wood Dale, IL 60191-1452 USA
P: 630-350-2252 Toll Free: 800-323-6859
F: 630-350-0232 E: info@tempco.com
www.tempco.com